

AVENTICS Series FSO Flat suction grippers

AVENTICS Series FSO are a range of oval flat suction cups ideal for long and cylindrical workpieces. Thanks to their oval shape, the contact surface available for establishing the vacuum is increased and optimized.



Technical data

Industry	Industrial
Min. ambient temperature	-10 °C
Max. ambient temperature	70 °C
Temporary ambient temperature (<30 s) min.	-30 °C
Temporary ambient temperature (<30 s) max.	120 °C
Compressed air connection	G 1/4
Holding force	50.1 N
Volume	2.3 cm ³
Max. curving on object R min	20 mm
Abrasion value according to DIN 535 16	100-120 mm ³
Hardness according to standard	60 ± 5 Shore A
Connection thread type	Internal thread
Material connector	Aluminum
Suction unit material	Acrylonitrile butadiene rubber
Delivery unit	1 piece
Weight	0.018 kg
Part No.	1820415142

Technical information

To be used on long, flat, and slightly curved surfaces.

Dimensions

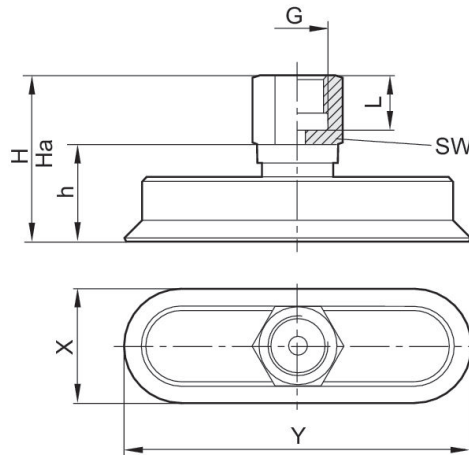

Part No.	X	Y	Ha*)	H	h	L	SW
1820415137	5	15	21.3	22	12	8.5	8
1820415138	6	18	21.2	22	12	8.5	8
1820415139	8	24	24	25	12	9	14
1820415140	10	30	23.5	25	12	9	14
1820415141	15	45	34	36	21	12	17
1820415142	20	60	33.5	36	21	12	17
1820415143	25	75	33.2	36	21	12	17
1820415144	30	90	32.5	36	21	12	17

*) Height for vacuum operation