

AVENTICS Series FSO Flat suction grippers

AVENTICS Series FSO are a range of oval flat suction cups ideal for long and cylindrical workpieces. Thanks to their oval shape, the contact surface available for establishing the vacuum is increased and optimized.



Technical data

Industry	Industrial
Min. ambient temperature	-30 °C
Max. ambient temperature	180 °C
Temperature resistance	Heat resistant
Temporary ambient temperature (<30 s) min.	-50 °C
Temporary ambient temperature (<30 s) max.	220 °C
Compressed air connection	G 1/4
Holding force	112.6 N
Volume	8.5 cm ³
Max. curving on object R min	35 mm
Abrasion value according to DIN 535 16	180-200 mm ³
Hardness according to standard	60 ± 5 Shore A
Connection thread type	Internal thread
Material connector	Aluminum
Suction unit material	Fluoromethyl silicone
Delivery unit	1 piece
Weight	0.035 kg
Part No.	1820415152

Oval suction gripper, Series FSO

2024-03-14

1820415152

Technical information

To be used on long, flat, and slightly curved surfaces.

Dimensions

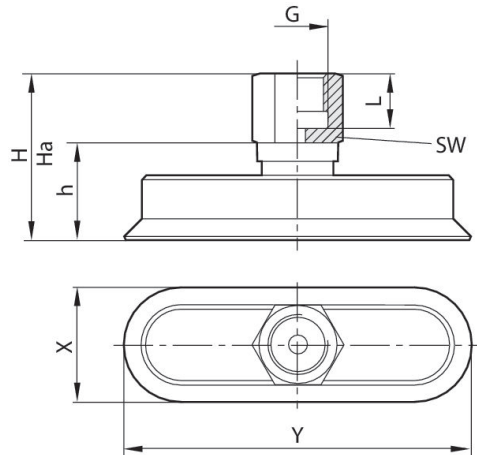

Part No.	G	X	Y	Ha*)	H	h	L	SW
1820415145	M5	5	15	21.3	22	12	8.5	8
1820415146	M5	6	18	21.2	22	12	8.5	8
1820415147	G 1/8	8	24	24	25	12	9	14
1820415148	G 1/8	10	30	23.5	25	12	9	14
1820415149	G 1/4	15	45	34	36	21	12	17
1820415150	G 1/4	20	60	33.5	36	21	12	17
1820415151	G 1/4	25	75	33.2	36	21	12	17
1820415152	G 1/4	30	90	32.5	36	21	12	17

*) Height for vacuum operation