

AVENTICS Series FSR Flat suction grippers

AVENTICS Series FSR As is a universal gripper with round flat suction cups making it the right choice for many standard applications with level, flat workpieces. It is available in a wide range of sizes up to diameters of 300 mm, and in different materials.

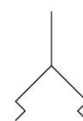

Technical data

Industry	Industrial
Min. ambient temperature	-20 °C
Max. ambient temperature	170 °C
Temperature resistance	Heat resistant
Compressed air connection	G 3/8
external diameter	100 mm
Holding force	304 N
Volume	56 cm ³
Max. curving on object R min	165 mm
Abrasion value according to DIN 535 16	154 mm ³
Hardness according to standard	60 ± 5 Shore A
Connection thread type	Internal thread
Material connector	Aluminum
Suction unit material	Fluoromethyl silicone
Weight	0.07 kg
Part No.	7321001000

Technical information

To be used on even, smooth, and rough surfaces.

Flat suction gripper, Series FSR

2024-03-14

7321001000

Dimensions

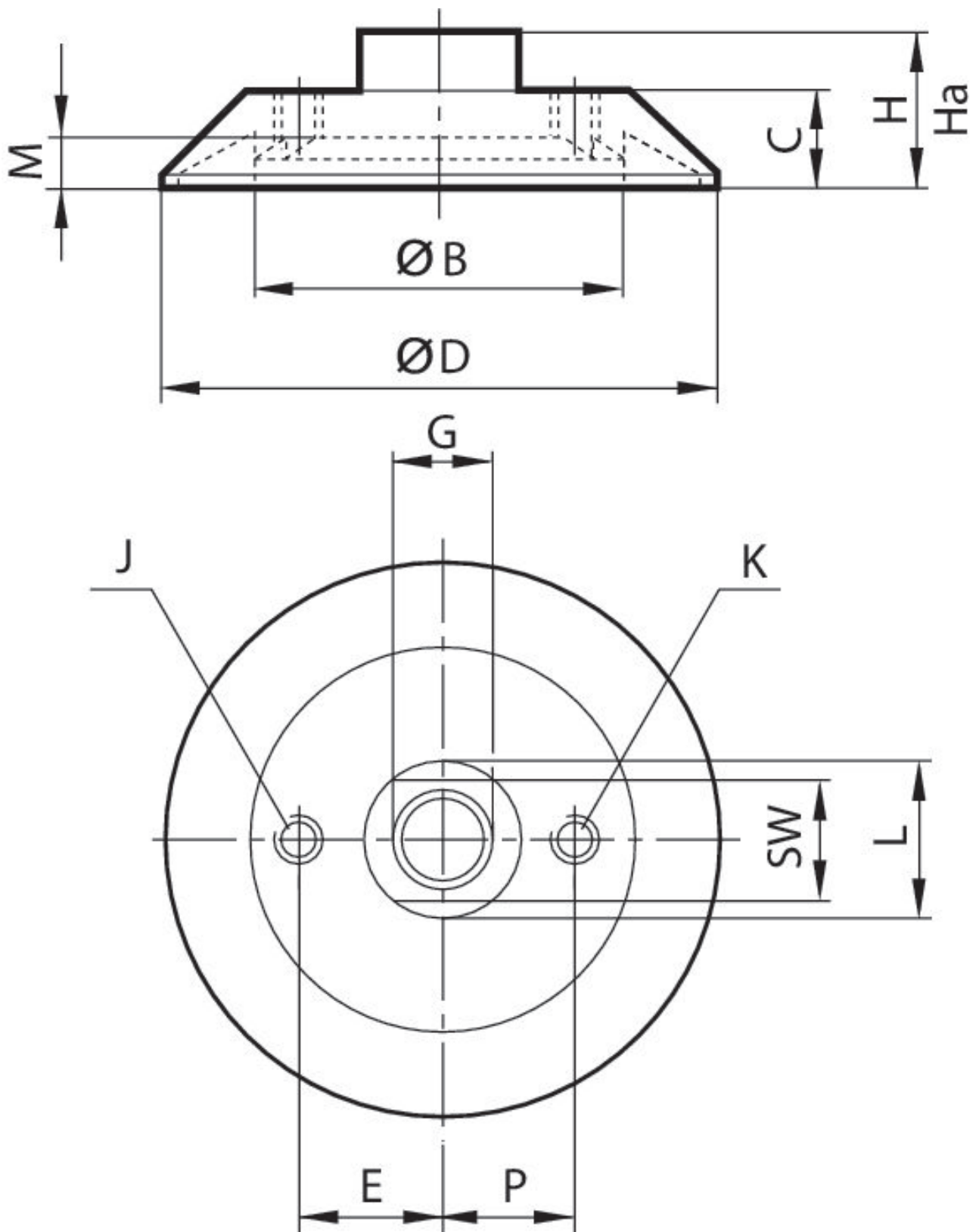

Flat suction gripper, Series FSR

2024-03-14

7321001000

Part No.	ØD	G	Ø B	C	E	H	Ha*)	J	K
7320301000	30	M5	13	10	–	17	14.5	–	–
7320501000	50	G 1/8	31	11	–	18	13.5	–	–
7320751000	75	G 1/4	49	14	–	22	16.5	–	–
7321001000	100	G 3/8	65.5	18	–	28	21	–	G 1/8
7321501000	150	G 1/2	96	26	–	42	33	–	G 1/8
7322251000	225	G 3/4	149	34	–	54	43	–	G 1/8
7323001000	300	G 1	200	44	70	70	55	G 1/2	G 1/8

Part No.	L	M	P	SW
7320301000	10	3.5	–	8
7320501000	18	5.5	–	14
7320751000	22	7	–	17
7321001000	24	8.5	20	21
7321501000	35	12	30	27
7322251000	50	14	50	41
7323001000	56	19	60	46

*) Height for vacuum operation

Technical information

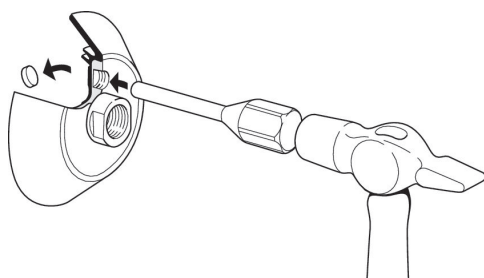

A ventilation valve can be connected at the thread connection of the suction cups Ø 100, 150, 225 and 300. For this, the plug must be knocked from the material with a hammer and mandrel.

Max. curving on object R min

