

## AVENTICS Series FSR Flat suction grippers

AVENTICS Series FSR As is a universal gripper with round flat suction cups making it the right choice for many standard applications with level, flat workpieces. It is available in a wide range of sizes up to diameters of 300 mm, and in different materials.

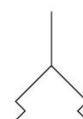

## Technical data

Industry	Industrial
Min. ambient temperature	-10 °C
Max. ambient temperature	70 °C
Compressed air connection	G 1/2
external diameter	150 mm
Holding force	608 N
Volume	160 cm <sup>3</sup>
Max. curving on object R min	306 mm
Abrasion value according to DIN 535 16	105 mm <sup>3</sup>
Hardness according to standard	60 ± 5 Shore A
Connection thread type	Internal thread
Material connector	Aluminum
Suction unit material	Chloroprene rubber
Weight	0.21 kg
Part No.	7321500000

## Technical information

To be used on even, smooth, and rough surfaces.

# Flat suction gripper, Series FSR

2024-03-14

7321500000

## Dimensions

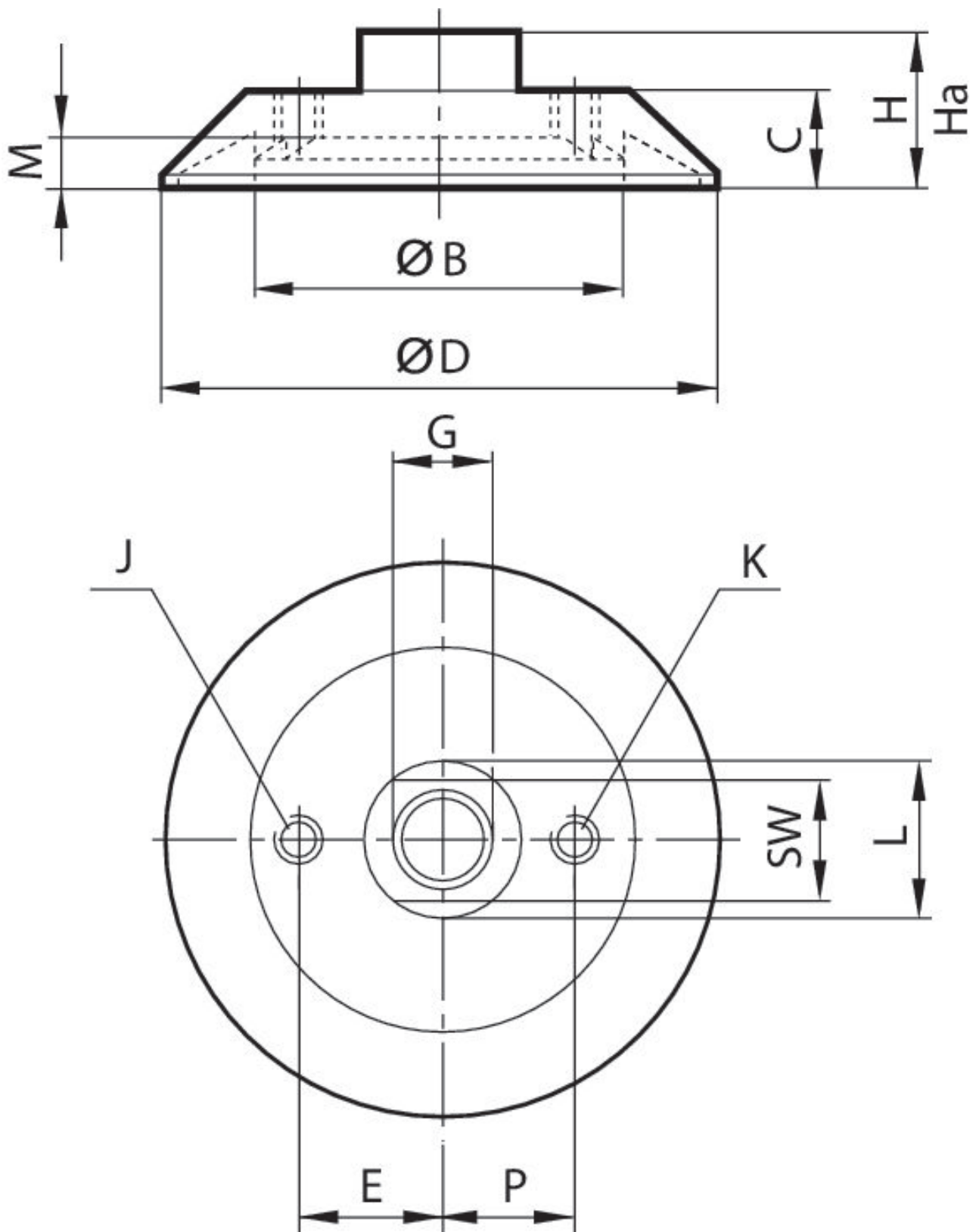

# Flat suction gripper, Series FSR

2024-03-14

7321500000

Part No.	ØD	G	Ø B	C	E	H	Ha*)	J	K
7320300000	30	M5	13	10	–	17	14.5	–	–
7320500000	50	G 1/8	31	11	–	18	13.5	–	–
7320750000	75	G 1/4	49	14	–	22	16.5	–	–
7321000000	100	G 3/8	65.5	18	–	28	21	–	G 1/8
7321500000	150	G 1/2	96	26	–	42	33	–	G 1/8
7322250000	225	G 3/4	149	34	–	54	43	–	G 1/8
7323000000	300	G 1	200	44	70	70	55	G 1/2	G 1/8

Part No.	L	M	P	SW
7320300000	10	3.5	–	8
7320500000	18	5.5	–	14
7320750000	22	7	–	17
7321000000	24	8.5	20	21
7321500000	35	12	30	27
7322250000	50	14	50	41
7323000000	56	19	60	46

\*) Height for vacuum operation

## Technical information

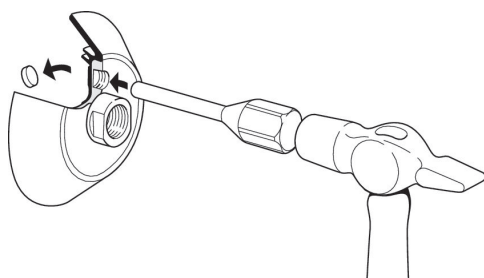

A ventilation valve can be connected at the thread connection of the suction cups Ø 100, 150, 225 and 300. For this, the plug must be knocked from the material with a hammer and mandrel.

Max. curving on object R min

