

Silencers, series S11

R412010687

General series information
AVENTICS Series S11 Silencers

- AVENTICS Series S11 Silencers offers a broad range of silencers even in Metal or plastic to reduce the noise when Pneumatic products come to exhaust.

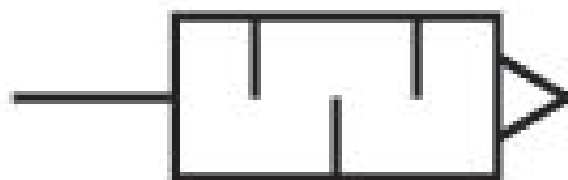

Technical data

Industry	Industrial
Medium	Compressed air
Working pressure min.	0 bar
Working pressure max	12 bar
Min. ambient temperature	-20 °C
Max. ambient temperature	150 °C
Compressed air connection	G 1/8
Compressed air connection type	External thread
Sound pressure level	73 dB
Nominal flow Qn	1218 l/min
Delivery unit	10 piece
Weight	0.01 kg

Material

Silencer material
Material thread
Part No.

Stainless Steel
Stainless Steel
R412010687

Dimensions

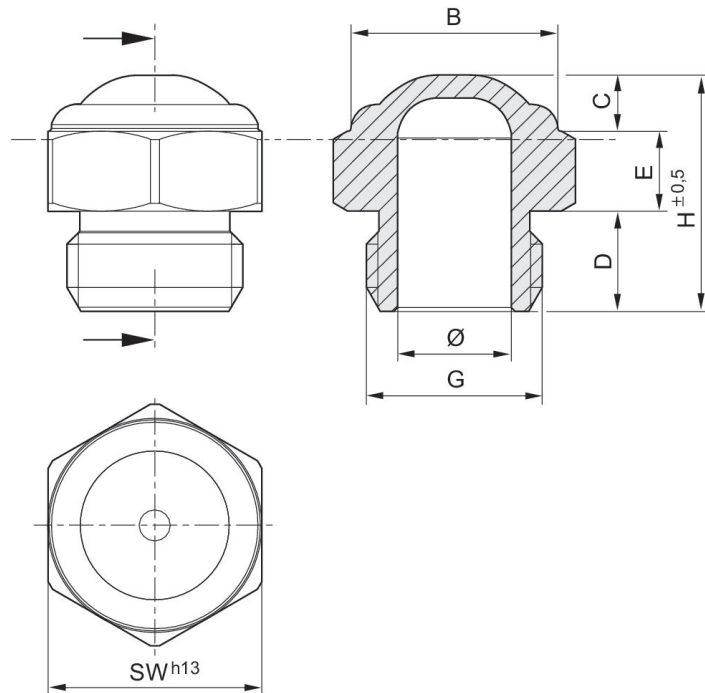

Part No.	Port G	Ø	B	D	E	H	SW
R412010686	M5	2.5	6.5	4	3	8	8
R412010687	G 1/8	6	11	6	4	15	13
R412007817	G 1/4	8.5	12	8	5	18	16

Flow diagram
R412010687

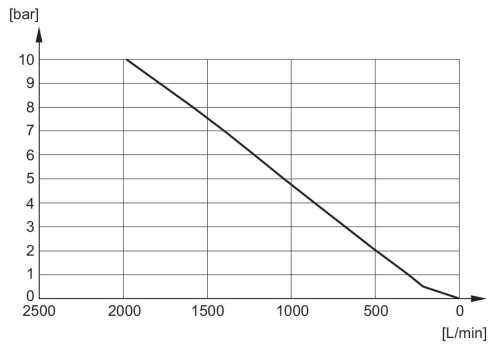

Flow diagram
R412007817

