

# Cross connection

1823390043

AVENTICS  
Distributors  
and  
distributor  
strips

## AVENTICS Distributors and distributor strips

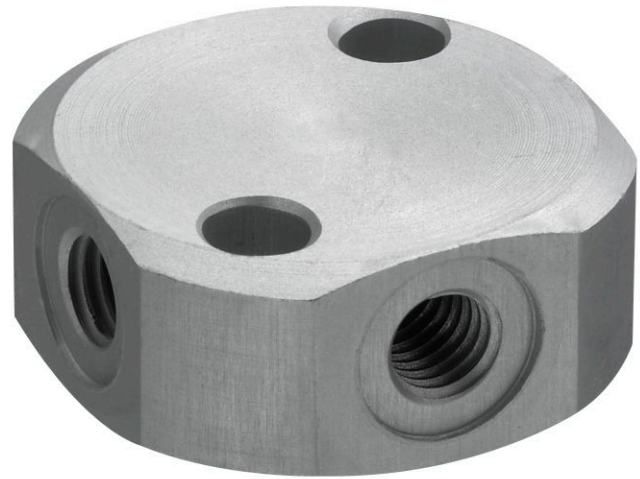

### Technical data

Industry	Industrial
Type	Distributor 4x
Port G	G 3/8
Working pressure min.	0 bar
Working pressure max	16 bar
Min. ambient temperature	-20 °C
Max. ambient temperature	80 °C
Delivery unit	1 piece
Weight	0.078 kg

### Material

Housing material	Aluminum
Surface housing	anodized
Part No.	1823390043

# Cross connection

1823390043

AVENTICS  
Distributors  
and  
distributor  
strips

## Dimensions

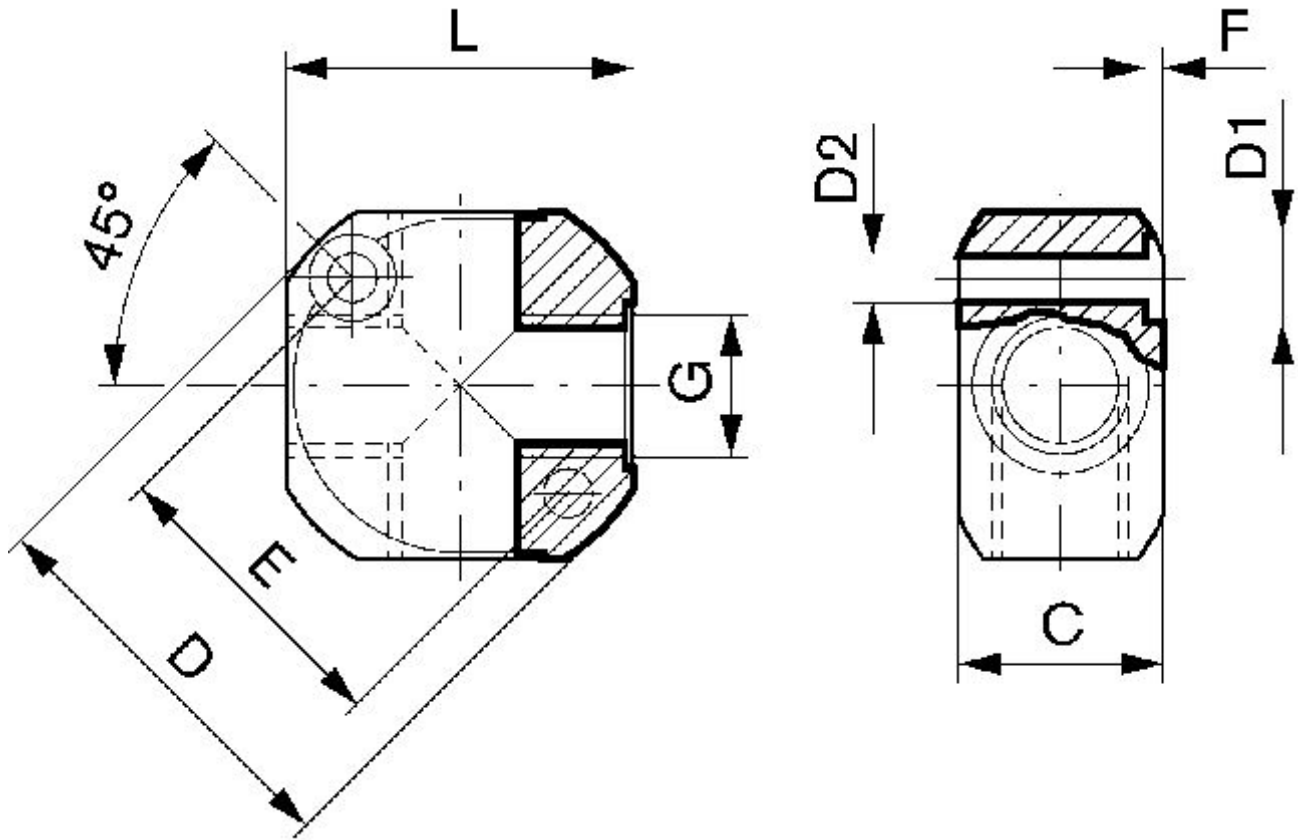

Part No.	G	C	D	D1	D2	E	F	L
1823390040	M5	10	25	7.4	4.3	17	1.5	22
1823390041	G 1/8	18	36	7.4	4.3	28	1.5	30
1823390042	G 1/4	21	43	7.4	4.3	33	1.5	36
1823390043	G 3/8	25	50	9.4	5.3	39	2	40
1823390044	G 1/2	30	60	10.4	6.4	48	2.5	50