

AVENTICS Series SH

The AVENTICS Series GPC is distinguished by high side load capacity and torsion protection. The drive and guide rods are robust and precise with high torque and transverse force absorption.

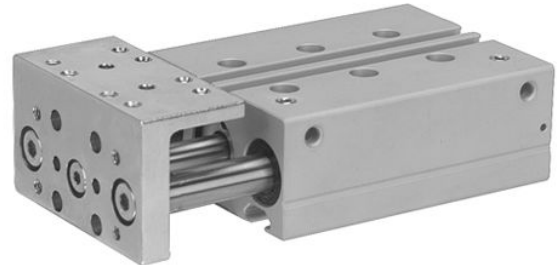

Technical data

Industry	Industrial
Piston Ø	16 mm
Piston rod Ø	8 mm
Stroke	30 mm
Functional principle	Double-acting
Bearing type	Plain bearing
Magnetic piston	with magnetic piston
Cushioning	elastic
Min. working pressure	2 bar
Max. working pressure	10 bar
Min. ambient temperature	-10 °C
Min. ambient temperature	14 °F
Max. ambient temperature	70 °C
Max. ambient temperature	158 °F
Min. oil content of compressed air	0 mg/m ³
Max. oil content of compressed air	5 mg/m ³
Port	M5
Retracting piston force	95 N
Retracting piston force	21.36 lbf

Guide cylinders, Series GPC-TL

0822061602

AVENTICS
Series SH

2024-03-18

Extracting piston force	127 N
Extracting piston force	28.55 lbf
Max. speed	0.5 m/s
Impact energy	0.11 J
Medium	Compressed air
Max. particle size	50 µm
Pressure for determining piston forces	6,3 bar
Weight	0.49 kg

Material

Housing material	Aluminum
Surface housing	anodized
Seal material	Polyurethane
Material front plate	Steel, chrome-plated
Surface front plate	galvanized
Material guide rods	Stainless Steel
Bearing material	Sintered bronze
Material piston rod	Stainless Steel
Part No.	0822061602

Technical information

The pressure dew point must be at least 15 °C less than ambient and medium temperature and may not exceed 3 °C.

The oil content of compressed air must remain constant during the life cycle.

Use only the approved oils from AVENTICS. Further information can be found in the "Technical information" document (available in <https://www.emerson.com/en-us/support>).

Guide cylinders, Series GPC-TL

0822061602

AVENTICS
Series SH

2024-03-18

Dimensions

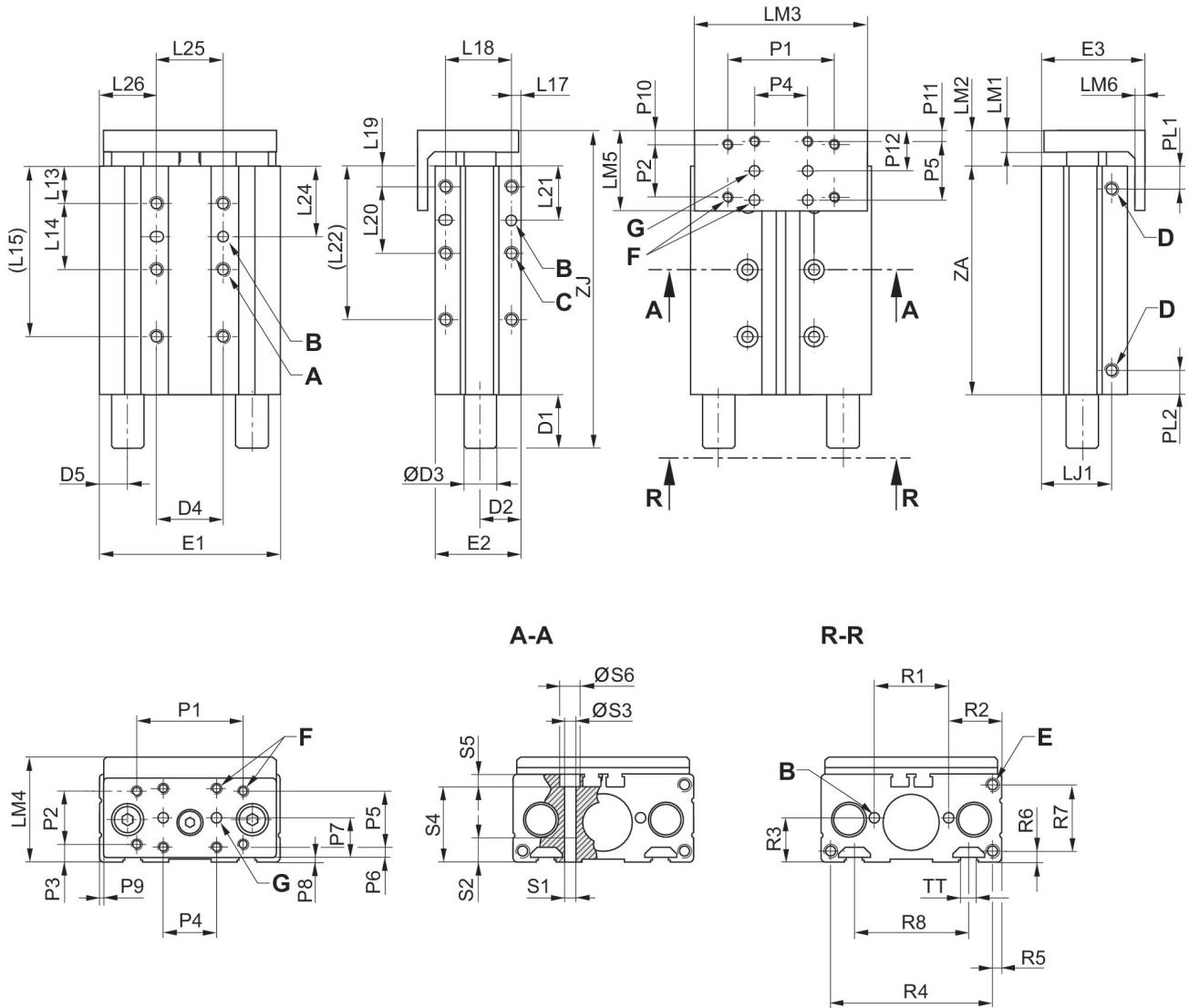

Piston Ø	A 1)	B 1)	C 1)	D	D1 S>30	D2	D3	D4	D5
12	M5x8	4 H7x4	M5x8	M5	17.6	14.5	10	40	9
16	M5x8	4 H7x4	M5x8	M5	20	15.8	12	47	10.5
20	M6x10	4 H7x4	M5x10	M5	20	16.5	12	54	13

Piston Ø	E 1)	E1	E2	E3	F	G	L13	L14 S=10	L14 S=20
12	M5x8	58	30.5	36.5	M4	4 H9	14.5	-	18
16	M5x8	68	33	39.5	M4	4 H9	14	18	25
20	M5x10	80	36	43.5	M5	4 H9	15	16	24

Piston Ø	L14 S>20	L15 S=50-150	L17	L18	L19	L20 S=10	L20 S=20-150	L21 S=10	L21 S>10
12	22	58.5	4	22	8	20	20	18	18
16	25	64	4	25	8	18	25	20.5	20.5

Guide cylinders, Series GPC-TL

0822061602

AVENTICS
Series SH

2024-03-18

Piston Ø	L14 S>20	L15 S=50-150	L17	L18	L19	L20 S=10	L20 S=20-150	L21 S=10	L21 S>10
20	24	63	4.5	24	8	20	30	18	23

Piston Ø	L22 S=50-150	L24 S=10	L24 S>10	L25	L26	LJ1	LM1	LM2	LM3
12	48	25.5	25.5	20	19	24.8	8	12.7	55
16	58	26.5	26.5	25	21.5	27	8	13.5	65
20	68	23	27	30	25	26.5	10	15.5	77

Piston Ø	LM4	LM5	LM6	P1	P2	P3	P4	P5	P6
12	35	28	4	40	20	3.5	20	20	3.5
16	38	30	4	40	20	5	20	22	4
20	42	35	5	50	25	4	25	25	4

Piston Ø	P7	P8	P9	P10	P11	P12	PL1	PL2	R1±0,04
12	13.5	1.5	1.5	4	4	14	8.5	8.5	23
16	15	1.5	1.5	5	4	15	8.8	8.8	28
20	16.5	1.5	1.5	5	5	17.5	10	10	30

Piston Ø	R2	R3	R4	R5	R6	R7	R8	S1	S2
12	17.5	15	50	4	4	22	–	M5	8
16	20	16.5	61	3.5	4	25	43	M5	8
20	25	18	70	5	3.5	29	50	M6	10

Piston Ø	S3	S4	S5	S6	TT	ZA	ZJ S=10-30	ZJ S>30
12	4.2	20	10.2	7.6	–	34.4	47.1	64.7
16	4.2	28.5	4.6	7.6	N6	36	49.5	69.5
20	5.2	30.5	5.5	9.5	N6	36	51.5	71.5

S = stroke

1) Dimension x depth

Permissible dynamic load m [kg]

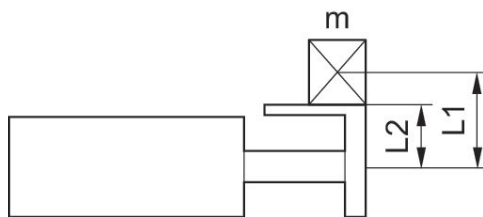

GPC combinations

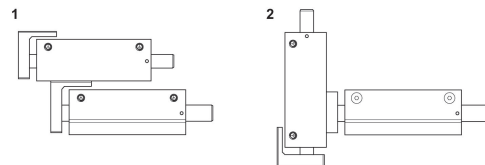

The GPC-TL can be directly mounted on the front plate of next bigger standard GPC in radial direction, and on next bigger GPC-TL in axial direction.

Guide cylinders, Series GPC-TL

0822061602

AVENTICS
Series SH

2024-03-18

Permissible lever arm length L_1 at 6 bar with dynamic load

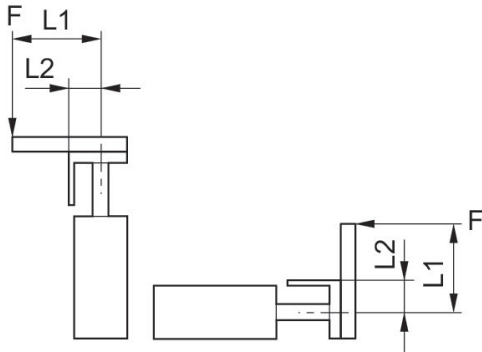

Permissible lever arm length L_1 at 6 bar with static load

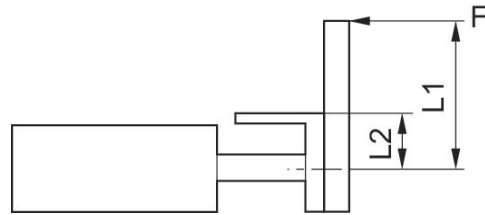

Permissible static moment M [Nm]

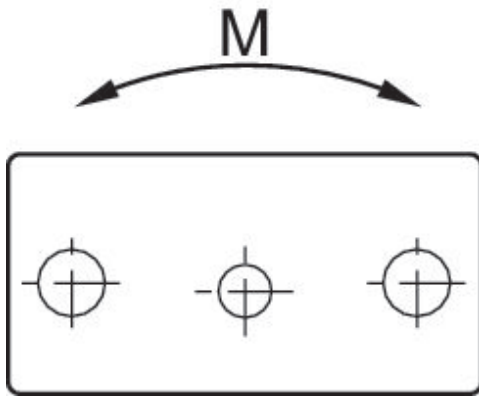

Permissible static side force F [N]
 \varnothing [[16] mm] and [[20] mm]

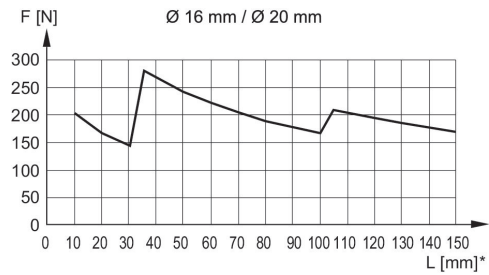

Permissible static side force F [N]
Ø12 mm

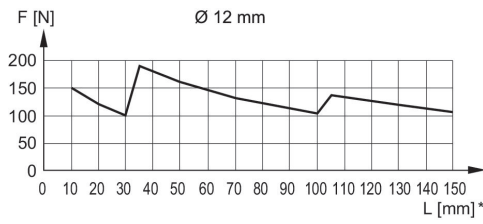

Permissible dynamic load m [kg]
Ø 20 mm

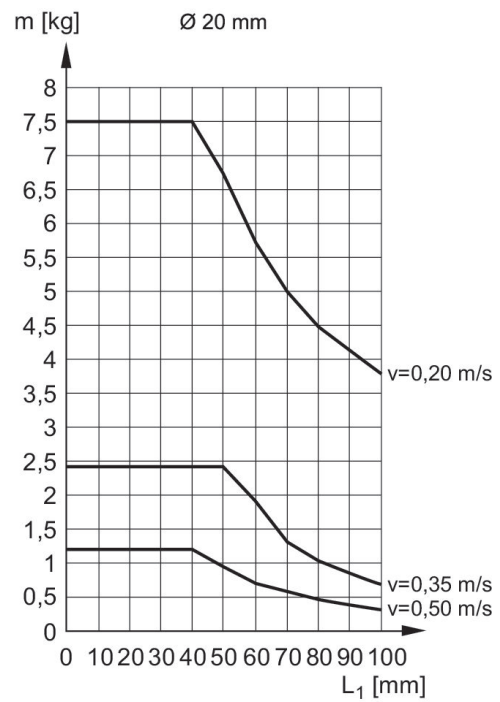

Permissible dynamic load m [kg]
Ø12 mm

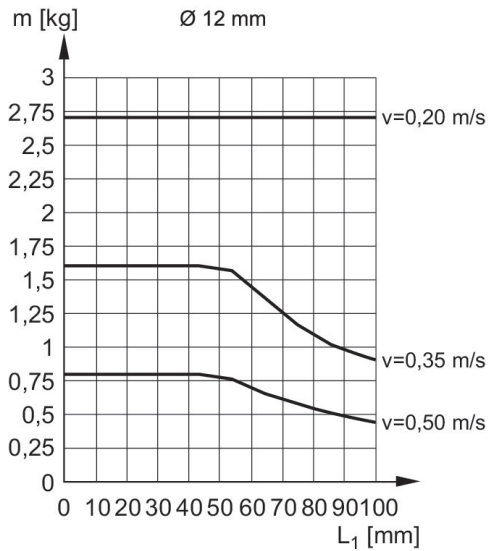

Permissible dynamic load m [kg]
Ø 16 mm

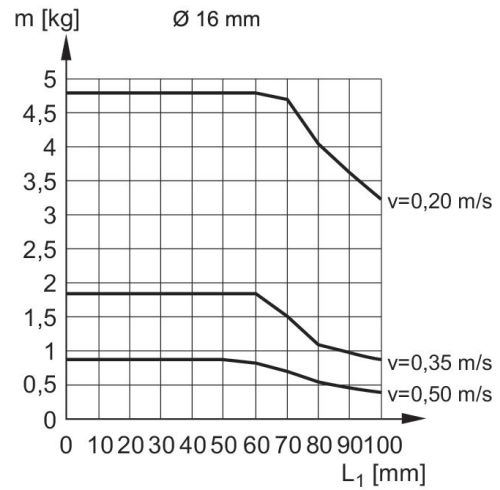

Guide cylinders, Series GPC-TL

0822061602

AVENTICS
Series SH

2024-03-18

Permissible static side force F [N]

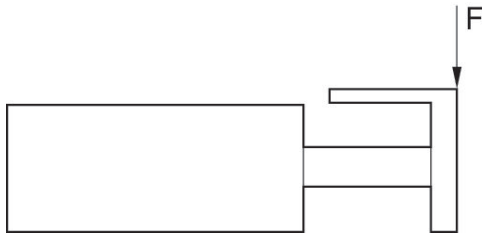

Overview drawing

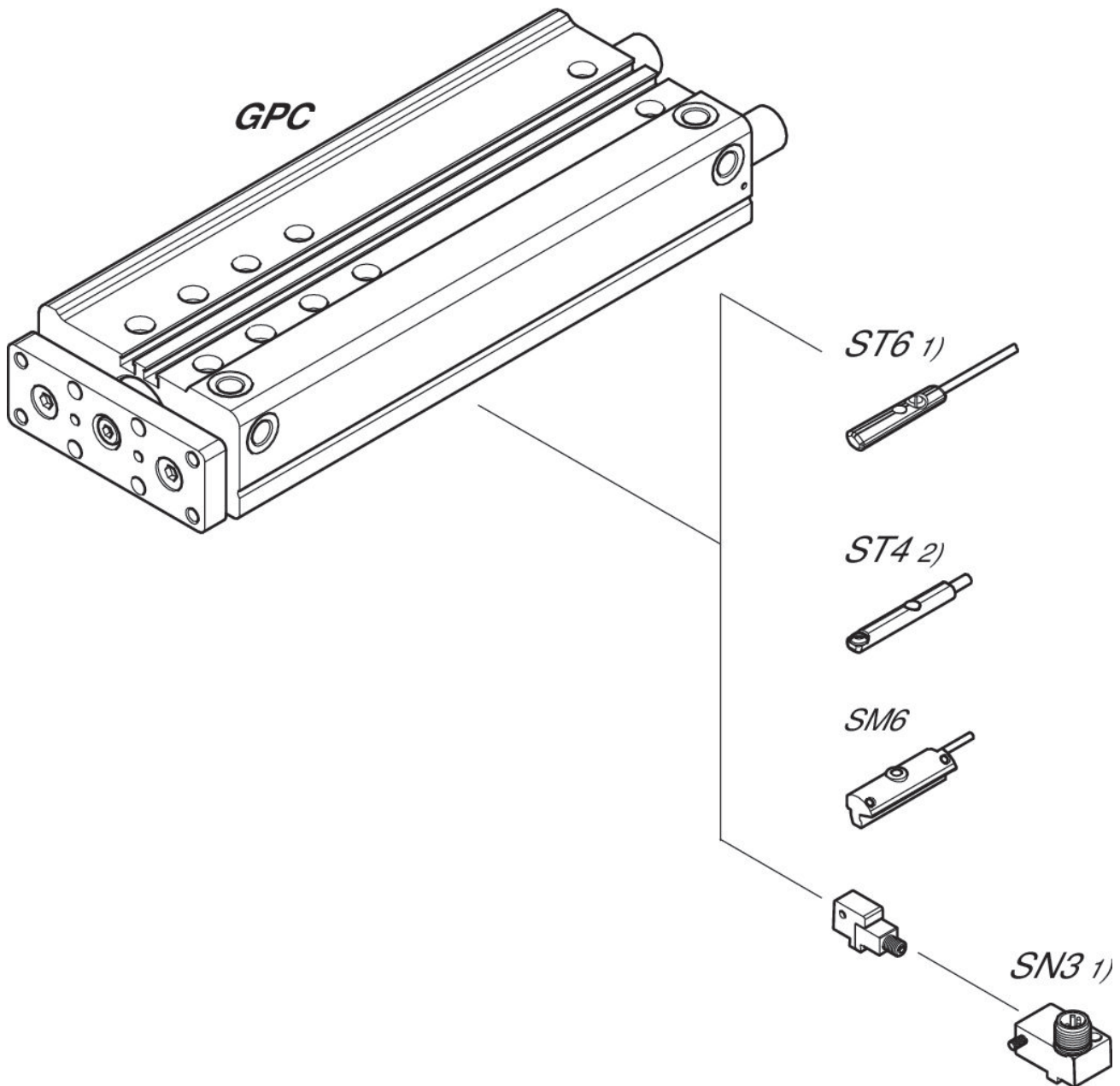

1) $\leq \text{Ø}12$ mm (GPC-BV, GPC-E, GPC-TL)

2) Only for $\text{Ø}10$ mm (GPC-BV) and all Ø (GPC-ST)

Guide cylinders, Series GPC-TL

0822061602

AVENTICS
Series SH

2024-03-18

NOTE: This overview drawing is only for orientation to indicate where the various accessory parts can be fastened to the cylinder. The illustration has been simplified for this purpose. It is thus not possible to derive the dimensions from this overview.