

AVENTICS Series SH

The AVENTICS Series GPC is distinguished by high side load capacity and torsion protection. The drive and guide rods are robust and precise with high torque and transverse force absorption.



Technical data

Industry	Industrial
Piston Ø	20 mm
Piston rod Ø	10 mm
Stroke	150 mm
Functional principle	Double-acting
Bearing type	ball bearing
Magnetic piston	with magnetic piston
Cushioning	elastic
Min. working pressure	2 bar
Max. working pressure	10 bar
Min. ambient temperature	-10 °C
Min. ambient temperature	14 °F
Max. ambient temperature	70 °C
Max. ambient temperature	158 °F
Min. oil content of compressed air	0 mg/m ³
Max. oil content of compressed air	5 mg/m ³
Port	M5
Retracting piston force	148 N
Retracting piston force	33.27 lbf

Guide cylinders, Series GPC-BV

0822062129

AVENTICS
Series SH

2024-03-18

Extracting piston force	198 N
Extracting piston force	44.51 lbf
Max. speed	0.5 m/s
Impact energy	0.15 J
Medium	Compressed air
Max. particle size	50 µm
Pressure for determining piston forces	6,3 bar
Weight	1.47 kg

Material

Housing material	Aluminum
Surface housing	anodized
Seal material	Polyurethane
Material front plate	Steel, chrome-plated
Surface front plate	galvanized
Material guide rods	Steel, chrome-plated
Surface guide rods	hardened
Bearing material	Steel, chrome-plated
Surface bearing	hardened
Material piston rod	Stainless Steel
Part No.	0822062129

Technical information

Note: Only the Ø10 variants fits to sensor series ST4. The sensor series ST6 and SN3 can be used for all other Ø variants.

The pressure dew point must be at least 15 °C less than ambient and medium temperature and may not exceed 3 °C.

The oil content of compressed air must remain constant during the life cycle.

Use only the approved oils from AVENTICS. Further information can be found in the "Technical information" document (available in <https://www.emerson.com/en-us/support>).

Dimensions

Guide cylinders, Series GPC-BV

0822062129

AVENTICS
Series SH

2024-03-18

Ø 10 ... 20

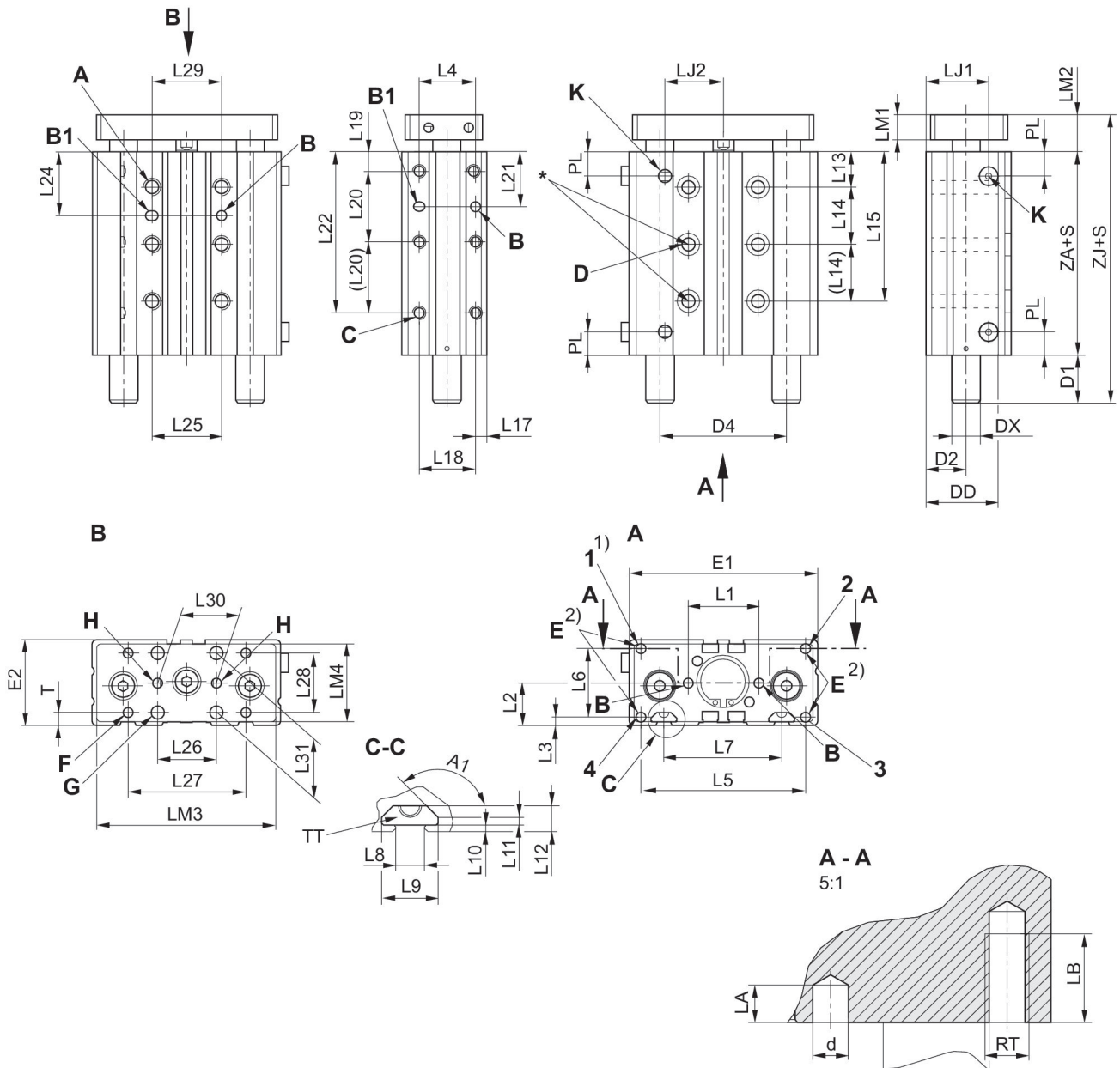

* Suitable for screws according to ISO 4762

1) Only Ø 20 threaded hole

2) M4 mounting hole for GPC-E accessories

1, 2, 3, 4: threaded holes

S = stroke

Note: Only the Ø10 variants fits to sensor series ST4. The sensor series ST6 and SN3 can be used for all other Ø variants.

Piston Ø	A RTxLB	A1	B ØdxLA	B1 ØdxDxLA	C RTxLB	D Ø	D1 S=10-30	D1 S=40-100	D1 S>100
10	M4x6	-	4H7x4	4H7x5x4	M4x6	3.2	13.5	13.5	13.5
12	M5x8	-	4H7x4	4H7x5x4	M5x8	4.2	0	18.4	33.4
16	M5x8	135°	4H7x4	4H7x5x4	M5x8	4.2	0	20.8	35.8
20	M6x10	135°	4H7x4	4H7x5x4	M6x10	5.2	0	20.8	35.8

Guide cylinders, Series GPC-BV

0822062129

AVENTICS
Series SH

2024-03-18

Piston Ø	D2	D4	DD	DX	E RTxLB	E1	E2	F Ø 1)	G Ø 2)
10	7	–	17.4	6	M4x8	50	21	M4	–
12	14.5	40	20	8	M5x8	58	30.5	M4	4.5
16	15.8	47	28.5	10	M5x8	68	33	M4	5.5
20	16.5	54	30.5	10	M5x10	80	36	M5	5.5

Piston Ø	H Ø 2)	K	L1	L2	L3	L4	L5	L6	L7
10	–	M5	20 ±0,04	10.5	3	–	20	15	–
12	4H9	M5	23 ±0,04	15	4	22	50	22	–
16	4H9	M5	28 ±0,04	16.5	4	25	61	25	43
20	4H9	M5	30 ±0,04	18	3.5	24	70	29	50

Piston Ø	L8	L9	L10	L11	L12	L13	L14 S=10	L14 S=20	L14 S>20
10	–	–	–	–	–	15	–	20	20
12	–	–	–	–	–	14.5	–	18	22
16	6.15	12	1.5	1.5	5.5	14	18	25	25
20	6.15	12	1.5	1.5	5.5	15	16	24	24

Piston Ø	L15 S=40	L15 S>40	L17	L18	L19	L20 S=10	L20 S>10	L21 S=10	L21 S>10
10	55	55	15	–	8	20	20	13 1)	13
12	–	58.5	4	22	8	20	20	18	18
16	–	64	4	25	8	18	25	20.5	20.5
20	–	63	4.5	24	8	20	30	18	23

Piston Ø	L22 S≤40	L22 S>40	L24 S=10	L24 S>10	L25	L26	L27	L28	L29
10	48	48	25	25	20	–	20	10	20
12	–	48	25.5	25.5	20	–	40	20	20
16	–	58	26.5	26.5	25	20	40	20	25
20	–	68	23	27	30	25	50	25	30

Piston Ø	L30	L31	LJ1	LJ2	LM1	LM2	LM3	LM4	PL
10	–	–	15.5	15	5	13.5	48	19	8
12	–	–	24.8	17.5	8	12.7	55	27	8.5
16	20 ±0,04	22	27	21	8	13.5	65	30	8.8
20	25 ±0,04	25	26.5	25	10	15.5	77	33	10

Piston Ø	T	TT	ZA	ZJ S=10-30	ZJ S=40-100	ZJ S>100
10	5.5	–	36	63	63	63
12	5	–	34.4	47.1	65.5	80.5
16	6.5	N6	36	49.5	70.3	85.3
20	5.5	N6	36	51.5	72.3	87.3

S = stroke
To determine the cylinder length (ZA) for intermediate strokes (i.e. stroke 10 with dia. 40), the next available standard stroke size must be used

1) Through hole with thread
2) through-hole
Two holes C-C 10 mm.

Guide cylinders, Series GPC-BV

0822062129

AVENTICS
Series SH

2024-03-18

Permissible static side load F [N] at distance L

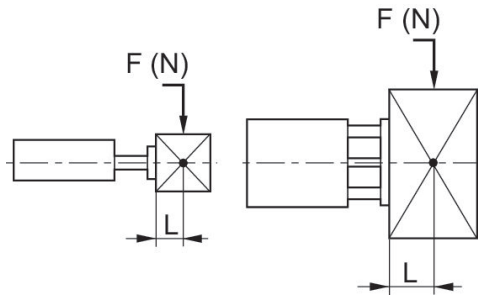

Permissible static moment M [Nm]

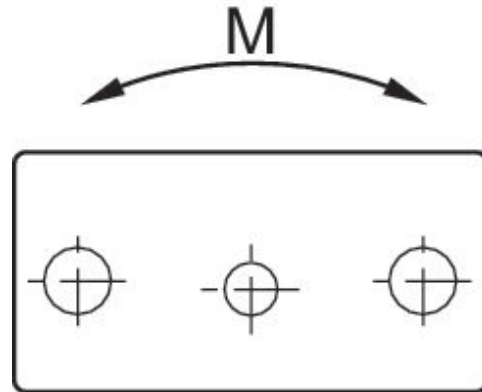

Permissible static side force F [N]

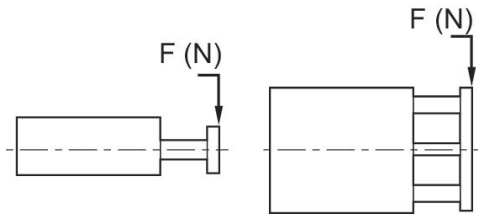

Permissible static moment M [Nm]

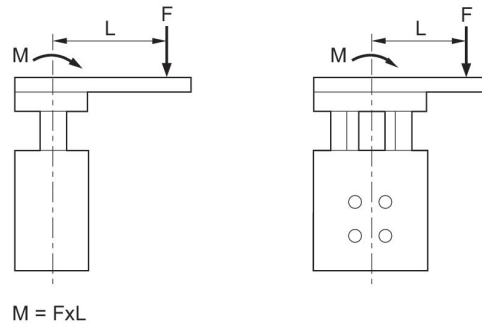

GPC combinations

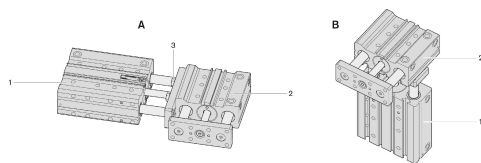

- 1) Cylinder 1
- 2) Cylinder 2
- 3) Screw

Guide cylinders, Series GPC-BV

0822062129

AVENTICS
Series SH

2024-03-18

Overview drawing

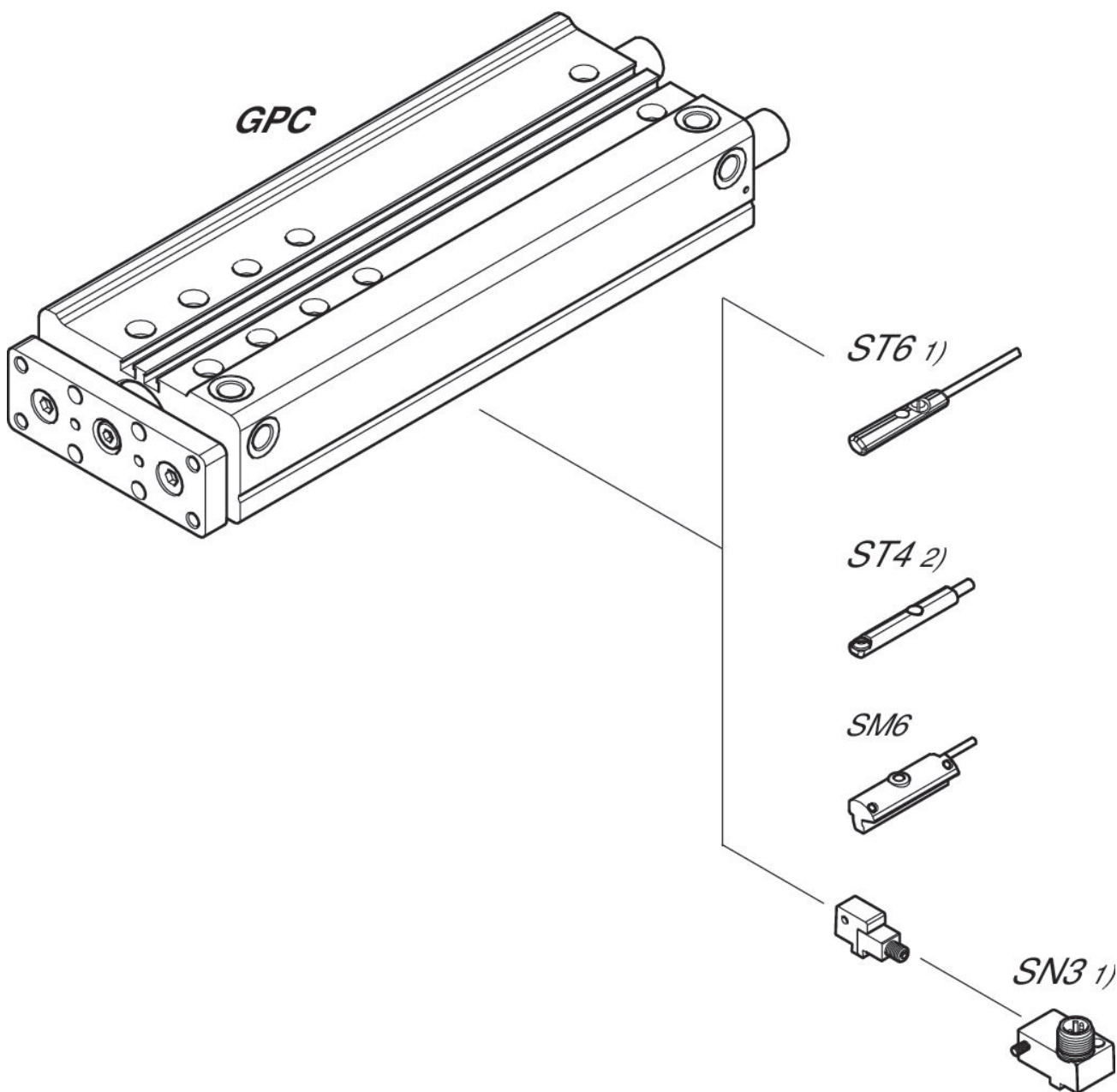

1) $\leq \varnothing 12$ mm (GPC-BV, GPC-E, GPC-TL)

2) Only for $\varnothing 10$ mm (GPC-BV) and all \varnothing (GPC-ST)

NOTE: This overview drawing is only for orientation to indicate where the various accessory parts can be fastened to the cylinder. The illustration has been simplified for this purpose. It is thus not possible to derive the dimensions from this overview.