

## AVENTICS Series SH

The AVENTICS Series GPC is distinguished by high side load capacity and torsion protection. The drive and guide rods are robust and precise with high torque and transverse force absorption.

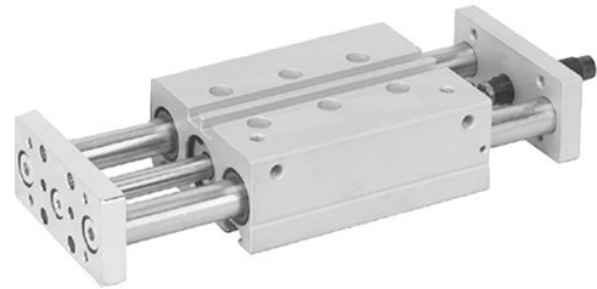

## Technical data

Industry	Industrial
Piston Ø	20 mm
Piston rod Ø	10 mm
Stroke	150 mm
Functional principle	Double-acting
Bearing type	Plain bearing
Magnetic piston	with magnetic piston
Cushioning	hydraulic
Cushioning	non-adjustable
Min. working pressure	2 bar
Max. working pressure	10 bar
Min. ambient temperature	0 °C
Min. ambient temperature	32 °F
Max. ambient temperature	65 °C
Max. ambient temperature	149 °F
Min. oil content of compressed air	0 mg/m <sup>3</sup>
Max. oil content of compressed air	5 mg/m <sup>3</sup>
Easy2Combine	Easy2Combine capable with connection kit
Port	M5
Retracting piston force	148 N
Retracting piston force	33.27 lbf
Extracting piston force	198 N
Extracting piston force	44.51 lbf
Max. speed	0.5 m/s
Impact energy	0.15 J
Medium	Compressed air

# Guide cylinders, Series GPC-E

0822062429

AVENTICS  
Series SH

2024-03-18

---

Max. particle size	50 µm
Pressure for determining piston forces	6,3 bar
Weight	1.86 kg

## Material

Housing material	Aluminum
Surface housing	anodized
Seal material	Polyurethane
Material front plate	Steel, chrome-plated
Surface front plate	galvanized
Material guide rods	Stainless Steel
Bearing material	Sintered bronze
Material piston rod	Stainless Steel
Part No.	0822062429

## Technical information

Note: Hydraulic shock absorber on rear side are included in scope of delivery

The pressure dew point must be at least 15 °C less than ambient and medium temperature and may not exceed 3 °C.

The oil content of compressed air must remain constant during the life cycle.

Use only the approved oils from AVENTICS. Further information can be found in the "Technical information" document (available in <https://www.emerson.com/en-us/support>).



# Guide cylinders, Series GPC-E

0822062429

AVENTICS  
Series SH

2024-03-18

Piston Ø	D4	E1	E2	F	G	H	L 4)	L13	L14
20	54	80	36	M5	5.5	M5	23	15	24

Piston Ø	L15 S=50-150	L17	L18	L19	L20	L21	L22 S=50-150	L24	L25
12	58.5	4	22	8	20	18	48	25.5	20
16	64	4	25	8	25	20.5	58	26.5	25
20	63	4.5	24	8	30	23	68	27	30

Piston Ø	L26	LJ1	LM1	LM2	LM3	LM4	P1	P2	P3
12	19	24.8	8	12.7	55	27	40	20	3.5
16	21.5	27	8	13.5	65	30	40	20	5
20	25	26.5	10	15.5	77	33	50	25	4

Piston Ø	P4	P5	P6	P7	P8	P9	PL1	PL2	PL3
12	-	-	-	-	1.5	1.5	8.5	8.5	11.5
16	20	22	4	15	1.5	1.5	8.8	8.8	13
20	25	25	4	16.5	1.5	1.5	10	10	15

Piston Ø	R8	S1 1)	S3	S4	S6	TT	ZJ	ZA
12	-	M5x8	4.2	20.3	7.6	-	66.3	34.4
16	43	M5x8	4.2	28.5	7.6	N6	75.3	36
20	50	M6x10	5.2	30.5	9.5	N6	78.3	36

S = stroke

1) Dimension x depth

2) Min.

3) Max.

4) Adjustment length L = A2 max. ... A2 min.

Permissible lever arm length L1 at 6 bar with dynamic load

Permissible lever arm length L1 at 6 bar with static load

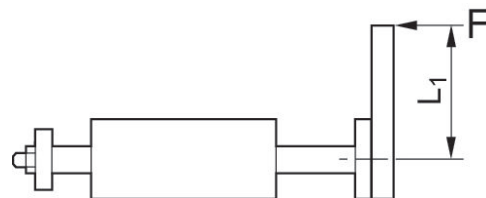
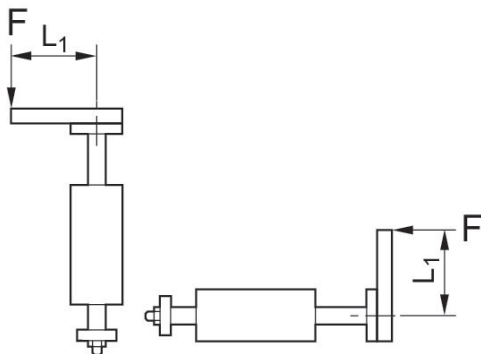

## GPC combinations

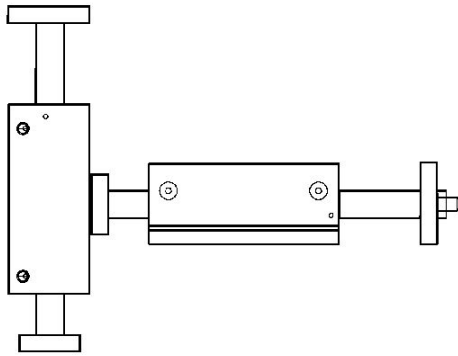

The GPC-E can be directly mounted on the front plate of next bigger standard GPC or GPC-E in radial direction.

## Permissible static moment M [Nm]

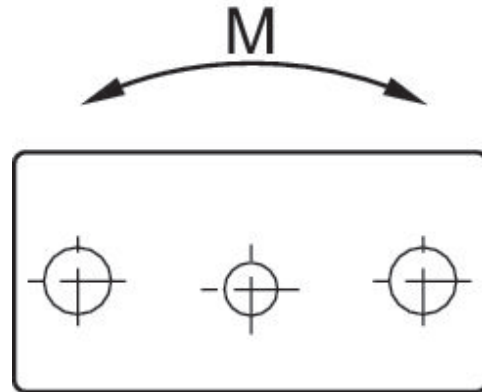

## Permissible static side force F [N] Ø [[16] mm] and [[20] mm]

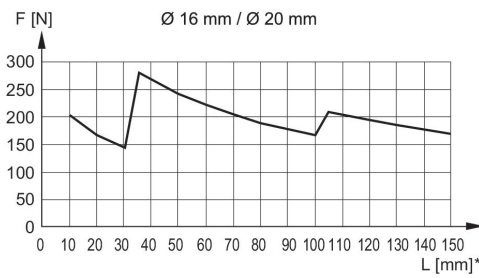

## Permissible static side force F [N] Ø 12 mm

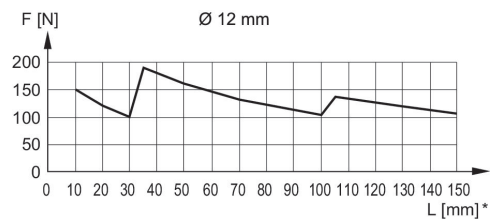

Permissible dynamic load  $m$  [kg]  
Ø 20 mm

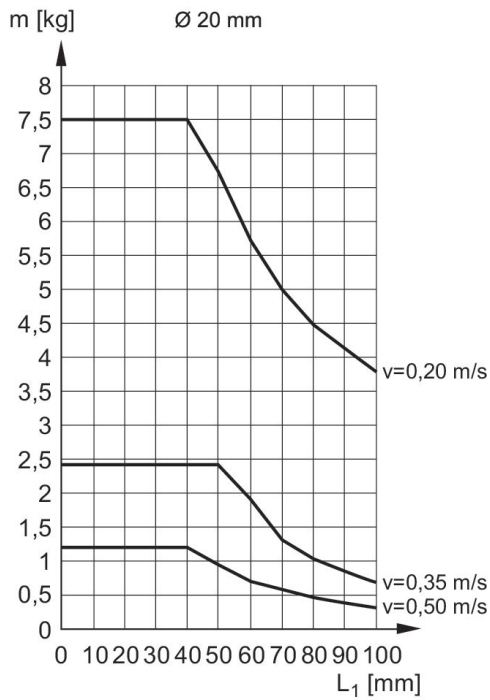

Permissible dynamic load  $m$  [kg]  
Ø 12 mm

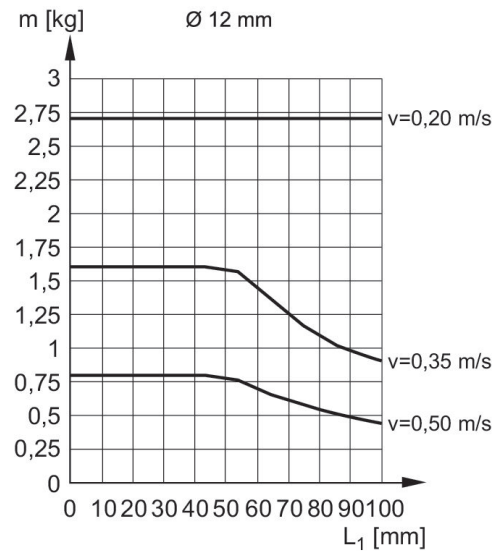

Permissible dynamic load  $m$  [kg]  
Ø 16 mm

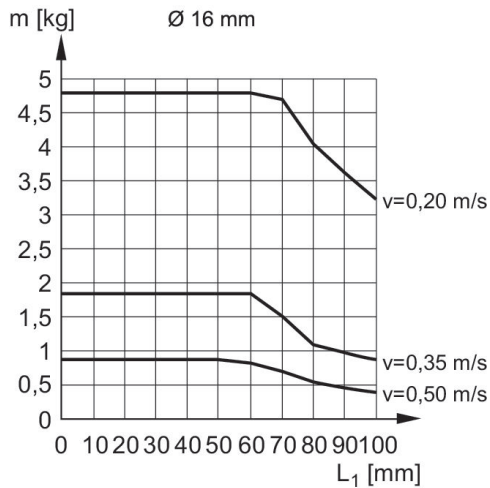

Permissible dynamic load  $m$  [kg]

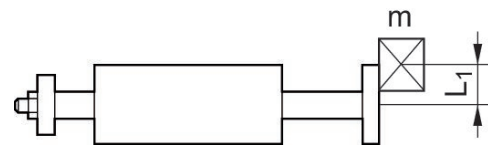

# Guide cylinders, Series GPC-E

0822062429

AVENTICS  
Series SH

2024-03-18

## Overview drawing

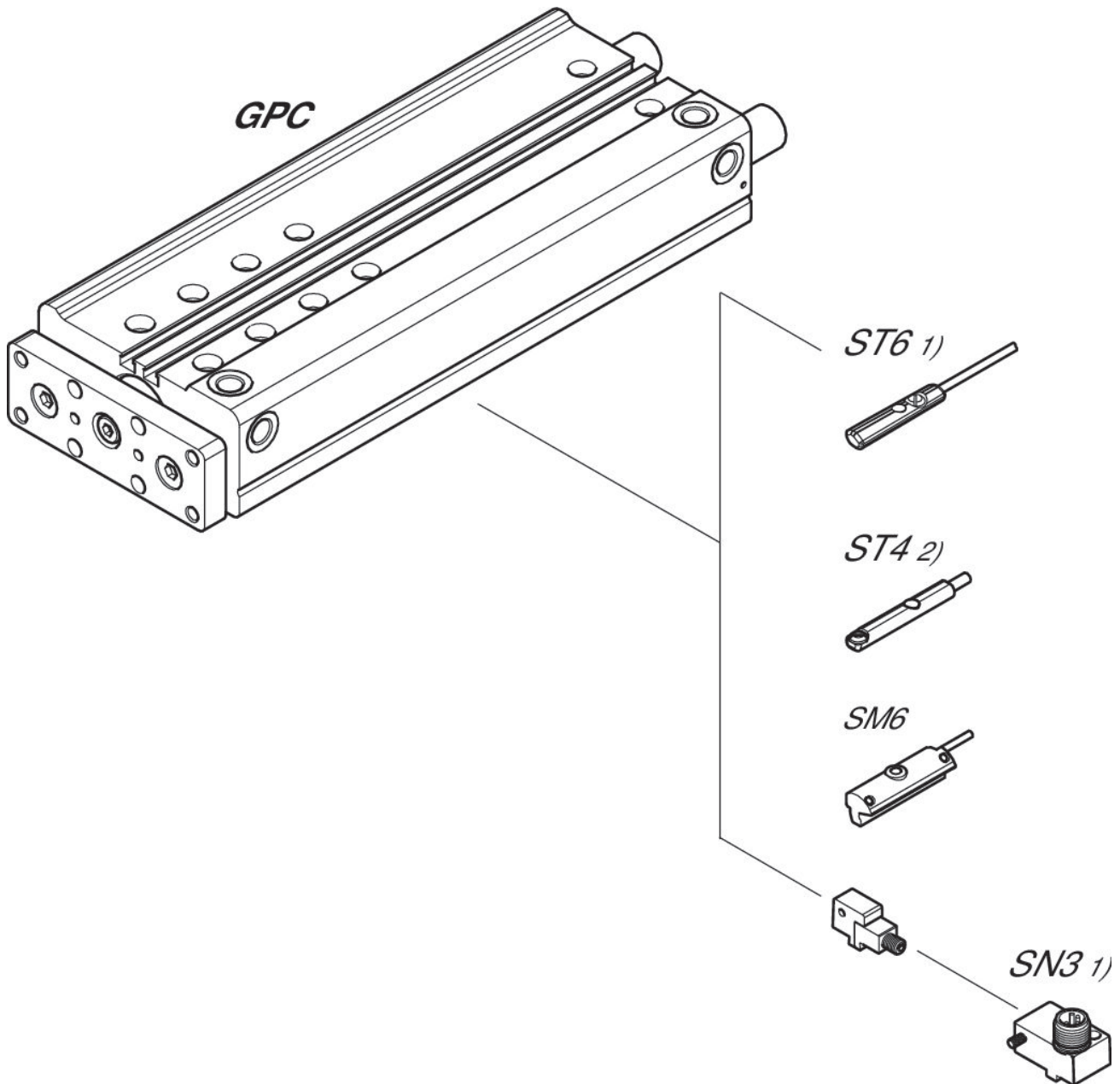

1)  $\leq \text{Ø}12$  mm (GPC-BV, GPC-E, GPC-TL)

2) Only for  $\text{Ø}10$  mm (GPC-BV) and all  $\text{Ø}$  (GPC-ST)

NOTE: This overview drawing is only for orientation to indicate where the various accessory parts can be fastened to the cylinder. The illustration has been simplified for this purpose. It is thus not possible to derive the dimensions from this overview.