

Guided slide unit, Series GSU

R402000997

AVENTICS
Series GSU
Guided
slide units

2024-03-18

Series GSU

AVENTICS Series GSU cylinders are the ideal basis for many handling systems. Stroke length and stroke position can be set variably along the entire length of the guided slide unit – individually from both sides, underscoring the great flexibility during installation. Their very low height and the option of ventilation from one side improve their integration capacity.

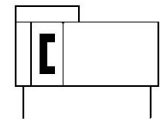

Technical data

Industry	Industrial
Piston Ø	25 mm
Stroke	400 mm
Ports	G 1/8
Functional principle	Double-acting
Magnetic piston	with magnetic piston
Guide	ball rail guide
Easy2Combine	capable
Piston force	309 N
Pressure for determining piston forces	6,3 bar
Cushioning length	12.5 mm
Cushioning energy	3.3 J
adjustable end stops	adjustable end stops
Cushioning	hydraulic
Cushioning	non-adjustable
Max. speed	1.5 m/s
Stroke max.	1000 mm
Min. working pressure	1.5 bar
Max. working pressure	8 bar

Guided slide unit, Series GSU

R402000997

AVENTICS
Series GSU
Guided
slide units

2024-03-18

Min. ambient temperature	0 °C
Max. ambient temperature	60 °C
Medium	Compressed air
Min. oil content of compressed air	0 mg/m ³
Max. oil content of compressed air	1 mg/m ³
Max. particle size	5 µm
Weight	4.25 kg

Material

Material cylinder tube	Aluminum
Surface cylinder tube	anodized
Material front cover	Aluminum
Surface cover	anodized
Seal material	Polyurethane
Material sealing strips	Polyurethane Stainless Steel
Material guide rail	Aluminum
Surface ball rail table	anodized
Material guide shuttle	Steel, chrome-plated
Material guide rail	Steel, chrome-plated
Surface guide rail	hardened
Part No.	R402000997

Technical information

The pressure dew point must be at least 15 °C less than ambient and medium temperature and may not exceed 3 °C.

The oil content of compressed air must remain constant during the life cycle.

Use only the approved oils from AVENTICS. Further information can be found in the “Technical information” document (available in <https://www.emerson.com/en-us/support>).

The pressure dew point must be at least 15 °C less than ambient and medium temperature and may not exceed 3 °C.

The oil content of compressed air must remain constant during the life cycle.

Use only the approved oils from AVENTICS. Further information can be found in the “Technical information” document (available in <https://www.emerson.com/en-us/support>).

Guided slide unit, Series GSU

R402000997

AVENTICS
Series GSU
Guided
slide units

2024-03-18

Dimensions

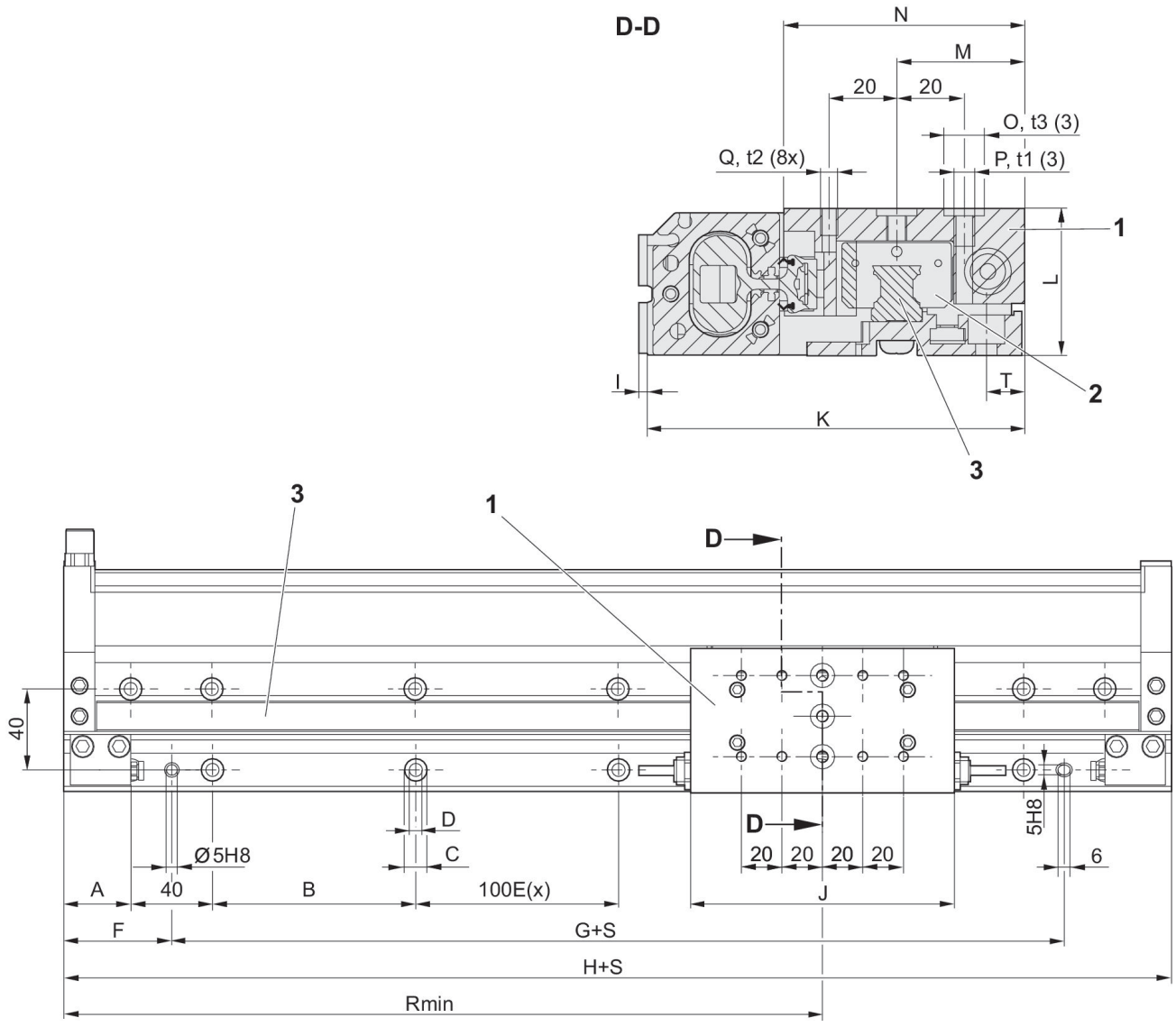

- S = stroke
- t1, t2 = depth of thread t3 = sinkhole depth
- 1) Ball rail table
- 2) Guide shuttle
- 3) Guide rail

Weight [kg]

Piston Ø	Stroke	200	300	400	500	600	700	800	900
16	E(x)	1	2	3	4	5	6	7	8
25	E(x)	1	2	3	4	5	6	7	8

Piston Ø	1000
16	9
25	9

Guided slide unit, Series GSU

R402000997

AVENTICS
Series GSU
Guided
slide units

2024-03-18

Piston Ø	A	B	C	D	F	G	H	I	J
16	25	92	Ø 9,5	Ø 5,5	45	124	214	3.6	110
25	33	100	Ø 11	Ø 6,6	53	140	246	2.5	130

Piston Ø	K	L	M	N	O	t3	P	t1	Q
16	99	29	33.5	69	Ø 9 H8	2,1 +0,2	M5	9	M4
25	111.65	43.5	37.85	71.15	Ø 12 H8	2,1 +0,2	M6	9	M5

Piston Ø	t2	R 1)	T
16	8	107	7.5
25	8	123	11.35

1) Min.

dynamic

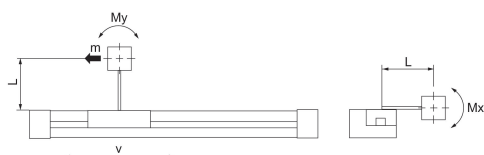

L indicates the distance between the mounting plate center and the center of mass of the attached parts.

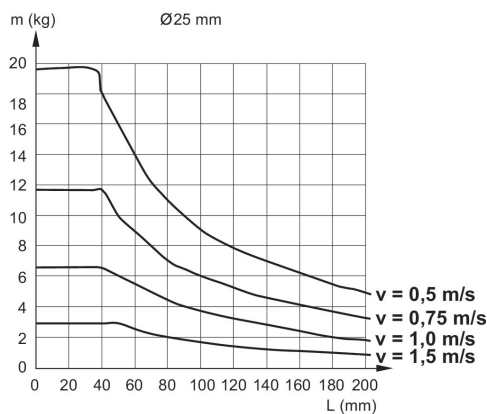

Permissible forces F_x , F_y , F_z and torques M_x , M_y , M_z

static

Guided slide unit, Series GSU

R402000997

AVENTICS
Series GSU
Guided
slide units

2024-03-18

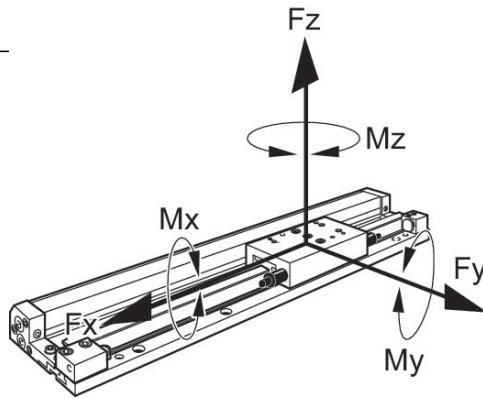

Piston \varnothing	F_x [N]	F_y [N]	F_z [N]	M_x [Nm]	M_y [Nm]	M_z [Nm]
16	880	880	1500	20	40	40
25	1070	1070	2500	55	65	65