

AVENTICS Series HU1 Holding units

The AVENTICS Series HU1 is a an holding unit using spring force. Holding cartridge can be exchanged in case of wear.

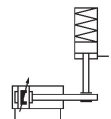

Technical data

Industry	Industrial
Function	Hold with clamping jaws
Function	hold: spring force, release: compressed air
Piston Ø	50 mm
suitable piston rod Ø	20 mm
Piston rod extension	57 mm
Compressed air connection	G 1/8
Min. release pressure	4 bar
Max. release pressure	8 bar
Min. medium temperature	-10 °C
Max. medium temperature	60 °C
Medium	Compressed air
Max. particle size	5 µm
Min. ambient temperature	-10 °C
Max. ambient temperature	60 °C
Min. oil content of compressed air	0 mg/m ³
Max. oil content of compressed air	5 mg/m ³
Static holding force	1600 N
Weight	0.57 kg

Material

Housing	Aluminum
Surface housing	black anodized
Part No.	0821401167

Technical information

Warning: The holding unit may not be used for the following applications: 1) for dynamic holding 2) in or as safety equipment

Holding unit may only be unlocked when turned off.

Make sure that the load direction does not change during a holding interval. A change in the direction of force, as well as external forces such as impacts, strong vibrations, or torsional forces, will briefly release the piston rod and may destroy the HU1 holding unit.

When clamped, there must be no residual pressure on the holding unit (0 bar).

Note: The minimum control pressure is \geq the working pressure of the cylinder!

Holding unit, Series HU1

0821401167

Holding unit

2023-10-26

Dimensions

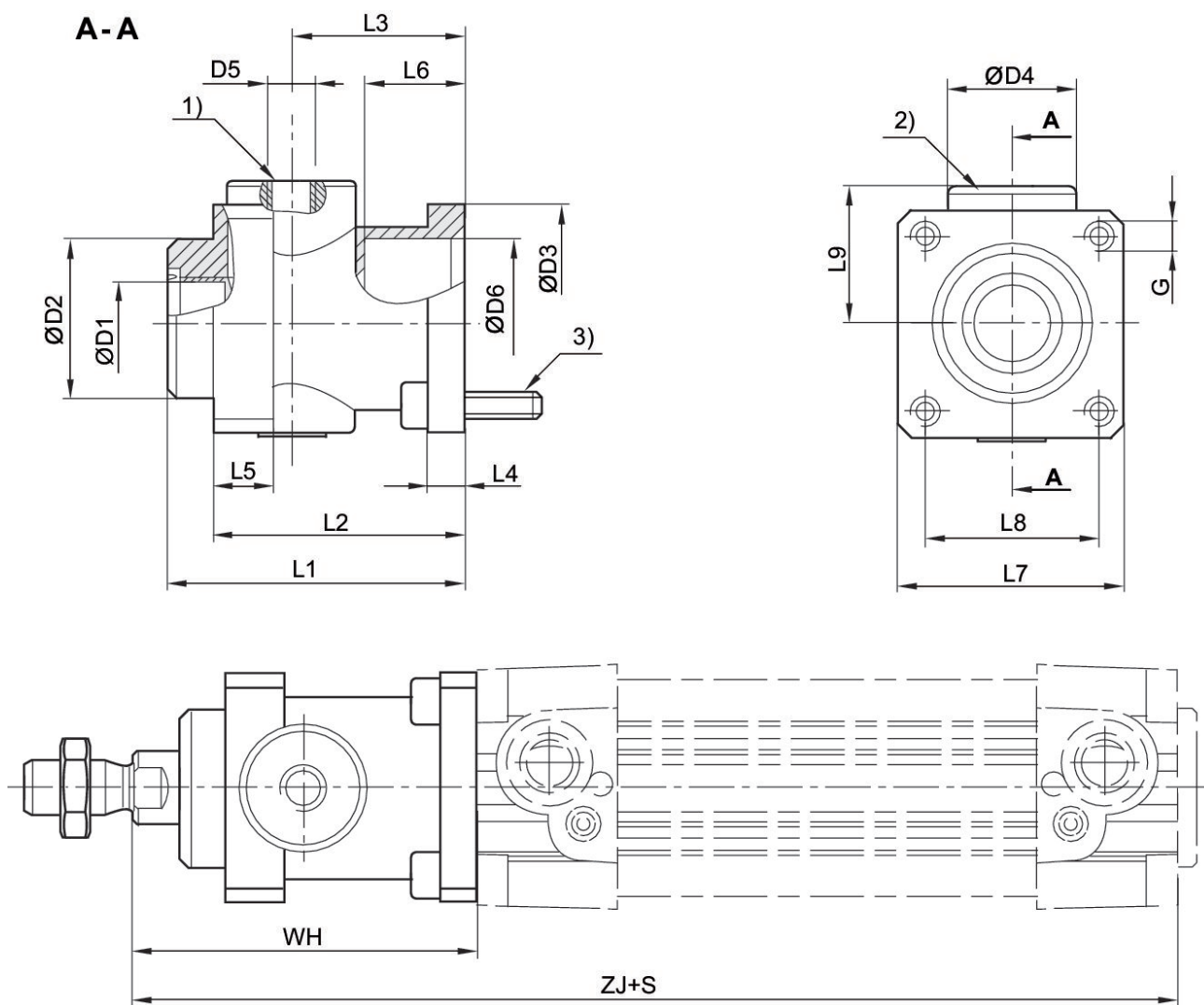

- 1) air connection
 - 2) Holding cartridge
 - 3) mounting screws 4x
- S = stroke

Piston Ø	Part No.	Ø D1	Ø D2	Ø D3	Ø D4	D5	L1	L2	L3
32	0821401165	12	30	35	25	M5	58	48	34
40	0821401166	16	35	40	28	G 1/8	65	55	38
50	0821401167	20	40	50	35	G 1/8	82	70	48
63	0821401168	20	45	60	38	G 1/8	82	70	49.5
80	0821401169	25	45	80	48	G 1/8	110	90	61
100	0821401170	25	55	100	58	G 1/8	115	100	69

Piston Ø	L4	L5	L6	L7	L8	L9	G	WH	ZJ
32	8	13	20.5	45	32.5	25.5	M6	68	162
40	8	13	22.5	50	38	30	M6	75	180

Holding unit, Series HU1

0821401167

Holding unit

2023-10-26

Piston Ø	L4	L5	L6	L7	L8	L9	G	WH	ZJ
50	15	16	29.5	60	46.5	36	M8	94	200
63	15	16	29.5	70	56.5	40	M8	94	215
80	18	20	35	90	72	50	M10	123	251
100	18	20	–	105	89	58	M10	128	266