

Blanking screw

2024-03-21

R402003750

AVENTICS Blanking screws and connectors

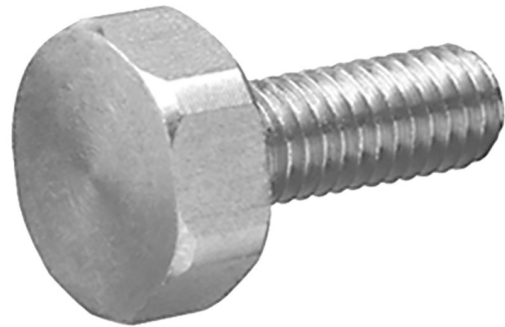

Technical data

Industry

Industrial

Port G

M8

Delivery unit

4 piece

Material

Material

Stainless Steel

Part No.

R402003750

Blanking screw

2024-03-21

R402003750

Dimensions

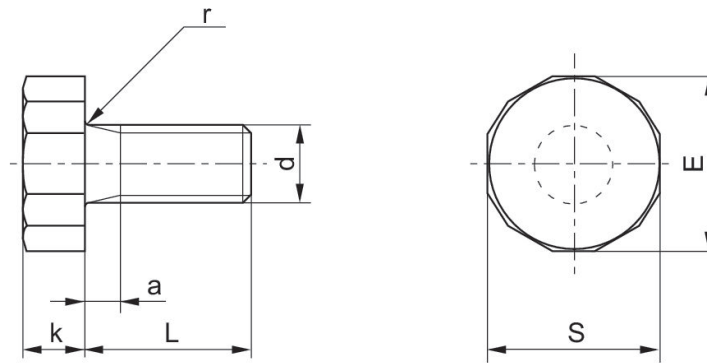

Dimensions in mm

Part No.	a	d	E	k	L	S	r
R412024762	2	M4	9.8	3.9	10	9.8	0.5
R412024763	3	M5	11	4	12	12	0.5
R402003749	3	M6	14	5.3	16	13	0.7
R402003750	3	M8	18	6.4	17	16	0.7