

AVENTICS Series ITS Tie rod cylinders (ISO 15552)

The AVENTICS Series ITS (ISO 15552) cylinders are often chosen when extremely large loads need to be moved efficiently and under control with the familiar ease of operation. The Series ITS (ISO 15552) cylinders are easily configurable to your application needs.

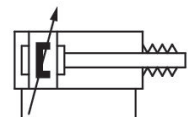
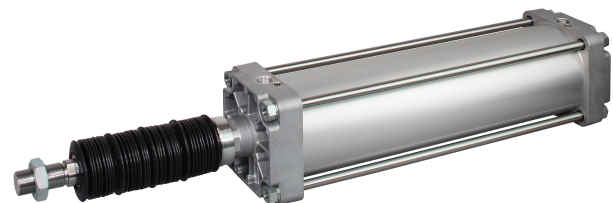

Technical data

Industry	Industrial
Standards	ISO 15552
Piston Ø	160 mm
Stroke	50 mm
Ports	G 3/4
Functional principle	Double-acting
Cushioning	Pneumatic adjustable cushioning
Magnetic piston	Piston with magnet
Environmental requirements	Industry standard
Piston rod thread - type	External thread
Piston rod thread	M36x2
Piston rod	single
Cylinder special features	Bellows
Scraper	Standard Industry Scraper
Pressure for determining piston forces	6,3 bar
Retracting piston force	11875 N
Extracting piston force	12667 N
Min. ambient temperature	-20 °C
Max. ambient temperature	80 °C

Tie rod cylinder ISO 15552, Series ITS

R481628002

series ITS

2024-04-05

Min. working pressure	2 bar
Max. working pressure	10 bar
Max. speed	0.6 m/s
Cushioning length	46 mm
Cushioning energy	160 J
Weight 0 mm stroke	12.89 kg
Weight +10 mm stroke	0.21 kg
Stroke max.	1000 mm
Medium	Compressed air
Min. medium temperature	-20 °C
Max. medium temperature	80 °C
Max. particle size	50 µm
Min. oil content of compressed air	0 mg/m ³
Max. oil content of compressed air	5 mg/m ³
Clamping piece for magnetic field sensor necessary	Clamping piece for magnetic field sensor necessary

Material

Piston rod	Stainless Steel
Scraper material	Acrylonitrile butadiene rubber
Material tie-rod	Stainless Steel
Seal material	Acrylonitrile butadiene rubber
Material, front cover	Die-cast aluminum
Cylinder tube	Aluminum
End cover	Die-cast aluminum
Nut for piston rod	Steel, chrome-plated
Bellow	Carboxylated nitrile rubber
Part No.	R481628002

Technical information

The pressure dew point must be at least 15 °C less than ambient and medium temperature and may not exceed 3 °C.

The oil content of compressed air must remain constant during the life cycle.

Use only the approved oils from AVENTICS. Further information can be found in the “Technical information” document (available in <https://www.emerson.com/en-us/support>).

Dimensions

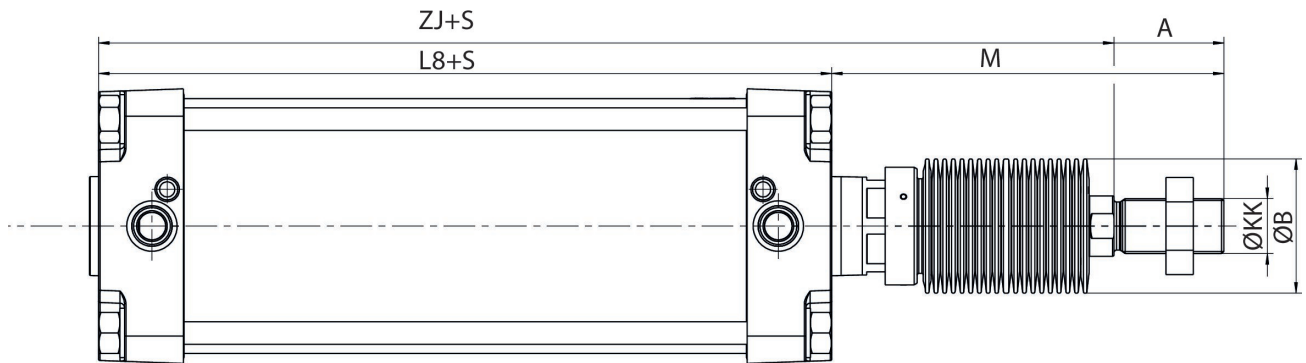

Stroke-dependent dimensions

Dimensions	M	M	M	M	M	ZJ	ZJ	ZJ	ZJ
Piston Ø	S=0-250	S=251-500	S=501-600	S=601-750	S=751-1000	S=0-250	S=251-500	S=501-600	S=601-750
160	222	266	311	321	386	330	374	419	429
200	237.5	281.5	326.5	336.5	401.5	346	390	435	445

Dimensions	ZJ	ZM	ZM	ZM	ZM	ZM
Piston Ø	S=751-1000	S=0-250	S=251-500	S=501-600	S=601-750	S=751-1000
160	494	480	568	658	678	808
200	510	511	599	689	709	839

S = stroke

Dimensions

Piston Ø	A	Ø B	KK	L8
160	72	88	M36x2	180
200	72	88	M36x2	180

Weight [kg]

Piston Ø	Stroke	Weight 0 mm stroke	Weight +10 mm stroke
160	0-125	12.89	0.21
160	126-250	13.10	0.21
160	251-500	20.41	0.21
160	501-600	27.84	0.21
160	601-750	31.04	0.21
160	751-1000	40.89	0.21
200	0-125	16.16	0.21
200	126-250	16.43	0.21

Tie rod cylinder ISO 15552, Series ITS

R481628002

series ITS

2024-04-05

Piston Ø	Stroke	Weight 0 mm stroke	Weight +10 mm stroke
200	251-500	25.67	0.21
200	501-600	34.98	0.21
200	601-750	38.99	0.21

Cushioning diagram

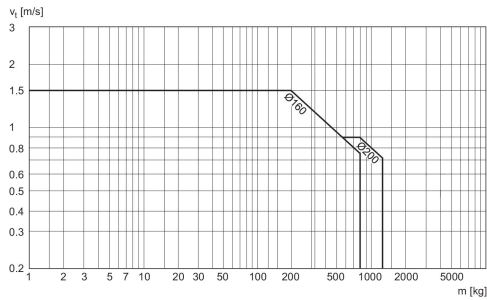

Tie rod cylinder ISO 1552, Series ITS

R481628002

series ITS

2024-04-05

Accessories overview

