

AVENTICS Series ITS Tie rod cylinders (ISO 15552)

The AVENTICS Series ITS (ISO 15552) cylinders are often chosen when extremely large loads need to be moved efficiently and under control with the familiar ease of operation. The Series ITS (ISO 15552) cylinders are easily configurable to your application needs.



Technical data

Industry	Industrial
Standards	ISO 15552
Piston Ø	200 mm
Stroke	25 mm
Ports	G 3/4
Functional principle	Double-acting
Cushioning	Pneumatic adjustable cushioning
Magnetic piston	Piston with magnet
Environmental requirements	Industry standard ATEX optional
Piston rod thread - type	External thread
Piston rod thread	M36x2
Piston rod	single
Scraper	Standard Industry Scraper
Pressure for determining piston forces	6,3 bar
Retracting piston force	19000 N
Extracting piston force	19792 N
Min. ambient temperature	-20 °C
Max. ambient temperature	80 °C
Min. working pressure	2 bar

Tie rod cylinder ISO 15552, Series ITS

R480627367

series ITS

2024-04-05

Max. working pressure	10 bar
Cushioning length	46 mm
Cushioning energy	170 J
Weight 0 mm stroke	15.67 kg
Weight +10 mm stroke	0.21 kg
Stroke max.	2700 mm
Medium	Compressed air
Min. medium temperature	-20 °C
Max. medium temperature	80 °C
Max. particle size	50 µm
Min. oil content of compressed air	0 mg/m ³
Max. oil content of compressed air	5 mg/m ³
Clamping piece for magnetic field sensor necessary	Clamping piece for magnetic field sensor necessary

Material

Piston rod	Stainless Steel
Scraper material	Acrylonitrile butadiene rubber
Material tie-rod	Stainless Steel
Seal material	Acrylonitrile butadiene rubber
Material, front cover	Die-cast aluminum
Cylinder tube	Aluminum
End cover	Die-cast aluminum
Nut for piston rod	Steel, chrome-plated
Part No.	R480627367

Technical information

ATEX-certified cylinders with identification II 2G Ex h IIC T4 Gb / II 2D Ex h IIIC T135°C Db_X can be generated in the Internet configurator.

The operating temperature range for ATEX-certified cylinders is -20°C ... 60°C.

The pressure dew point must be at least 15 °C less than ambient and medium temperature and may not exceed 3 °C.

The oil content of compressed air must remain constant during the life cycle.

Use only the approved oils from AVENTICS. Further information can be found in the "Technical information" document (available in <https://www.emerson.com/en-us/support>).

Tie rod cylinder ISO 15552, Series ITS

R480627367

series ITS

2024-04-05

Dimensions

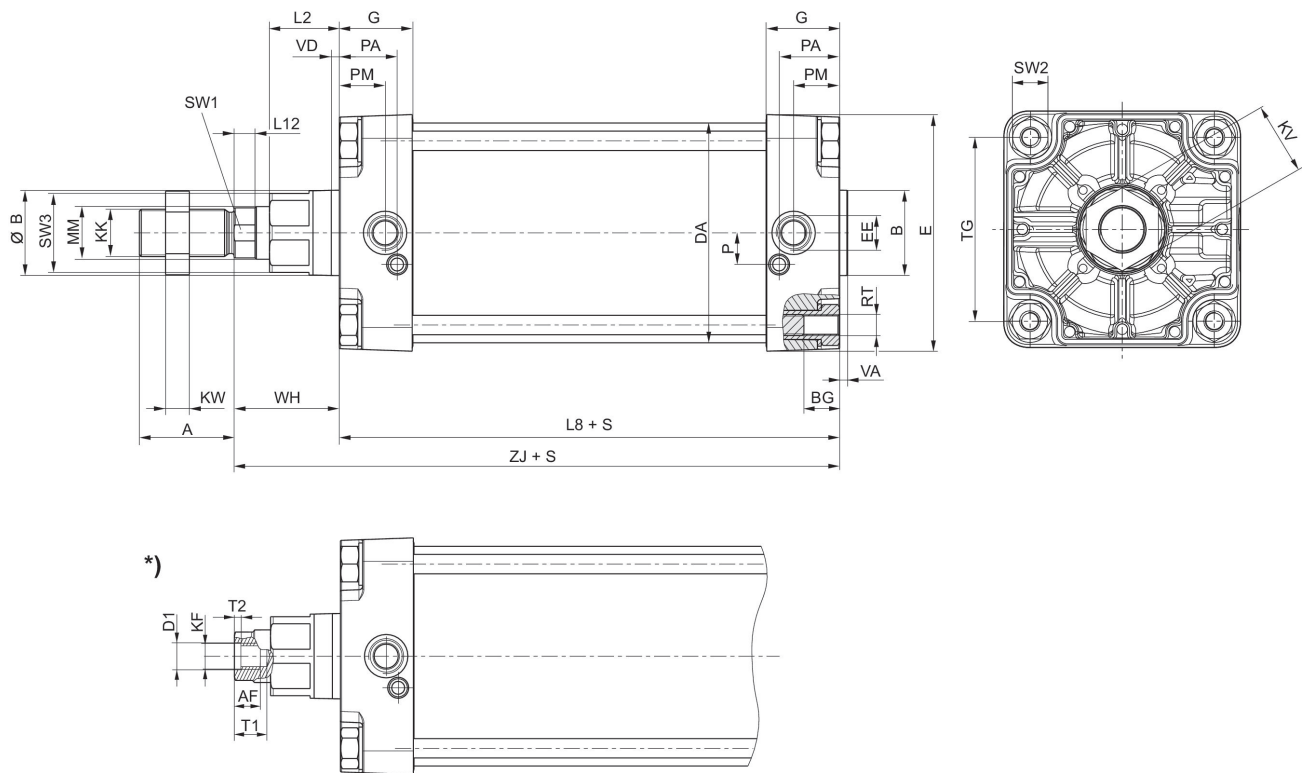

S = stroke

*) For cylinders with optional piston rod with internal thread

Piston Ø	A	AF	B	ØB	BG	D1	DA	E	EE
160	72	36	65	65	24	25	167	180	G 3/4
200	72	36	75	75	24	25	210	220	G 3/4
250	84	50	90	90	25	31	262	280	G 1
320	96	55	110	110	28	37	336	350	G 1

Piston Ø	G	KF	KK	KV	KW	L2	L8	L12	MM
160	56	M24	M36x2	55	18	53	180	16	40
200	54	M24	M36x2	55	18	56	180	16	40
250	59.5	M30	M42x2	65	21	67	200	20	50
320	61.5	M36	M48x2	75	24	76	220	23.25	63

Piston Ø	P	PA	PM	RT	SW1	SW2	SW3	T1	T2
160	24	45	35	M16	36	27	60	40	10
200	22.5	42	30	M16	36	27	60	40	10
250	29	46	32.8	M20	46	41	80	60	10
320	30	48	37	M24	55	50	95	65	13

Piston Ø	TG	VA	VD	WH	ZJ
160	140	6	6	80	260

Tie rod cylinder ISO 1552, Series ITS

R480627367

series ITS

2024-04-05

Piston Ø	TG	VA	VD	WH	ZJ
200	175	6	6	95	275
250	220	10	31	105	305.3
320	270	10	34	120	340.5

Cushioning diagram

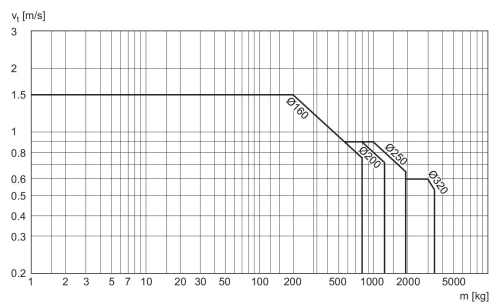

v_i = Piston velocity [m/s] m = Cushionable mass [kg]

Tie rod cylinder ISO 1552, Series ITS

R480627367

series ITS

2024-04-05

Overview drawing



NOTE: This overview drawing is only for orientation to indicate where the various accessory parts can be fastened to the cylinder. The illustration has been simplified for this purpose. It is thus not possible to derive the dimensions from this overview.