

AVENTICS Series ITS Tie rod cylinders (ISO 15552)

The AVENTICS Series ITS (ISO 15552) cylinders are often chosen when extremely large loads need to be moved efficiently and under control with the familiar ease of operation. The Series ITS (ISO 15552) cylinders are easily configurable to your application needs.



Technical data

Industry	Industrial
Standards	ISO 15552
Piston Ø	200 mm
Stroke	200 mm
Ports	G 3/4
Functional principle	Double-acting
Cushioning	Pneumatic adjustable cushioning
Magnetic piston	Piston with magnet
Environmental requirements	Industry standard ATEX optional
Piston rod thread - type	External thread
Piston rod thread	M36x2
Piston rod	single
Cylinder special features	with trunnion mounting
Scraper	Standard Industry Scraper
Pressure for determining piston forces	6,3 bar
Retracting piston force	19000 N
Extracting piston force	19792 N
Min. ambient temperature	-20 °C
Max. ambient temperature	80 °C

Tie rod cylinder ISO 15552, Series ITS

series ITS

R480627421

2024-04-05

Min. working pressure	2 bar
Max. working pressure	10 bar
Cushioning length	46 mm
Cushioning energy	170 J
Weight 0 mm stroke	20.25 kg
Weight +10 mm stroke	0.21 kg
Stroke max.	2700 mm
Medium	Compressed air
Min. medium temperature	-20 °C
Max. medium temperature	80 °C
Max. particle size	50 µm
Min. oil content of compressed air	0 mg/m ³
Max. oil content of compressed air	5 mg/m ³
Clamping piece for magnetic field sensor necessary	Clamping piece for magnetic field sensor necessary

Material

Piston rod	Stainless Steel
Scraper material	Acrylonitrile butadiene rubber
Material tie-rod	Stainless Steel
Seal material	Acrylonitrile butadiene rubber
Material, front cover	Die-cast aluminum
Cylinder tube	Aluminum
End cover	Die-cast aluminum
Nut for piston rod	Steel, chrome-plated
Trunnion mounting	Nodular graphite iron
Part No.	R480627421

Technical information

The trunnion mounting is positioned in the center at the factory and can be adjusted later.

ATEX-certified cylinders with identification II 2G Ex h IIC T4 Gb / II 2D Ex h IIIC T135°C Db_X can be generated in the Internet configurator.

The operating temperature range for ATEX-certified cylinders is -20°C ... 60°C.

The pressure dew point must be at least 15 °C less than ambient and medium temperature and may not exceed 3 °C.

The oil content of compressed air must remain constant during the life cycle.

Use only the approved oils from AVENTICS. Further information can be found in the "Technical information" document (available in <https://www.emerson.com/en-us/support>).

Dimensions

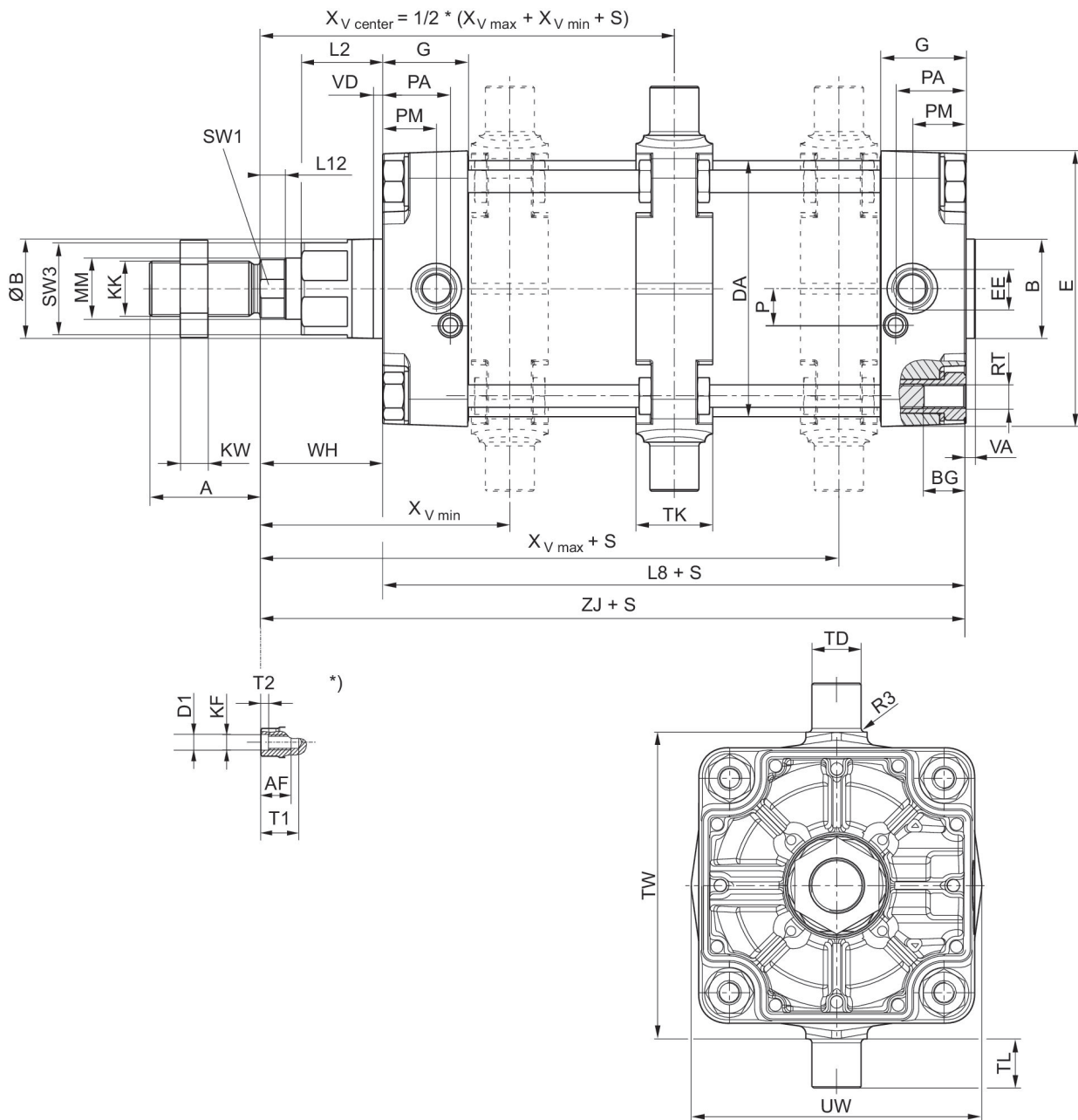

S = stroke

*) For cylinders with optional piston rod with internal thread

Piston Ø	A	B	ØB	BG	DA	E	EE	G	KK
160	72	65	65	24	167	180	G 3/4	56	M36x2
200	72	75	75	24	210	220	G 3/4	54	M36x2
250	84	90	90	25	262	280	G 1	59.5	M42x2
320	96	110	110	28	336	350	G 1	61.5	M48x2

Tie rod cylinder ISO 1552, Series ITS

R480627421

series ITS

2024-04-05

Piston Ø	KV	KW	L2	L8	L12	MM	P	PA	PM
160	55	18	53	180	16	40	24	45	35
200	55	18	56	180	16	40	22.5	42	30
250	65	21	67	200	20	50	29	46	32.8
320	75	24	76	220	23.25	63	30	48	37

Piston Ø	R3	RT	SW1	SW2	SW3	TD e9	TG	TK	TL h14
160	2.5	M16	36	27	60	32	140	50	32
200	2.5	M16	36	27	60	32	175	50	32
250	3	M20	46	41	80	40	220	60	40
320	3.2	M24	55	50	95	50	270	70	50

Piston Ø	TW h14	UW	VD	WH	XV min	XV max	ZJ
160	200	190	6	80	163	177	260
200	250	240	6	95	177	193	275
250	320	310	31	105	195	215	305.3
320	400	400	34	120	228	233	340.5

Cushioning diagram

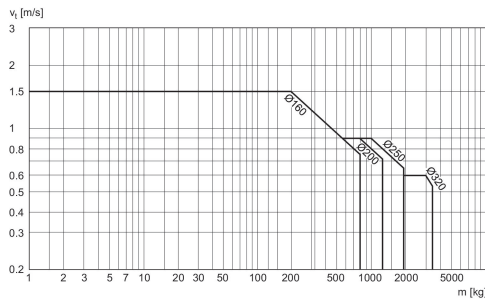

v_t = Piston velocity [m/s] m = Cushionable mass [kg]

Tie rod cylinder ISO 1552, Series ITS

R480627421

series ITS

2024-04-05

Overview drawing



NOTE: This overview drawing is only for orientation to indicate where the various accessory parts can be fastened to the cylinder. The illustration has been simplified for this purpose. It is thus not possible to derive the dimensions from this overview.