

AVENTICS Series ITS Tie rod cylinders (ISO 15552)

The AVENTICS Series ITS (ISO 15552) cylinders are often chosen when extremely large loads need to be moved efficiently and under control with the familiar ease of operation. The Series ITS (ISO 15552) cylinders are easily configurable to your application needs.

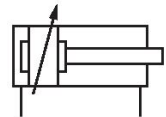

Technical data

Industry	Industrial
Standards	ISO 15552
Piston Ø	200 mm
Stroke	250 mm
Ports	G 3/4
Functional principle	Double-acting
Cushioning	Pneumatic adjustable cushioning
Magnetic piston	Piston without magnet
Environmental requirements	Industry standard Heat resistant
Piston rod thread - type	External thread
Piston rod thread	M36x2
Piston rod	single
Scraper	Heat-Resistant Scraper
Pressure for determining piston forces	6,3 bar
Retracting piston force	19000 N
Extracting piston force	19792 N
Min. ambient temperature	-10 °C
Max. ambient temperature	150 °C
Min. working pressure	2 bar

Tie rod cylinder ISO 15552, Series ITS

R480627386

series ITS

2024-04-05

Max. working pressure	10 bar
Cushioning length	46 mm
Cushioning energy	170 J
Weight 0 mm stroke	15.67 kg
Weight +10 mm stroke	0.21 kg
Stroke max.	2700 mm
Medium	Compressed air
Min. medium temperature	-10 °C
Max. medium temperature	150 °C
Max. particle size	50 µm
Min. oil content of compressed air	0 mg/m ³
Max. oil content of compressed air	5 mg/m ³

Material

Piston rod	Stainless Steel
Scraper material	Fluorocaoutchouc
Material tie-rod	Stainless Steel
Seal material	Fluorocaoutchouc
Material, front cover	Die-cast aluminum
Cylinder tube	Aluminum
End cover	Die-cast aluminum
Nut for piston rod	Steel, chrome-plated
Part No.	R480627386

Technical information

The pressure dew point must be at least 15 °C less than ambient and medium temperature and may not exceed 3 °C.

The oil content of compressed air must remain constant during the life cycle.

Use only the approved oils from AVENTICS. Further information can be found in the "Technical information" document (available in <https://www.emerson.com/en-us/support>).

Tie rod cylinder ISO 15552, Series ITS

R480627386

series ITS

2024-04-05

Dimensions

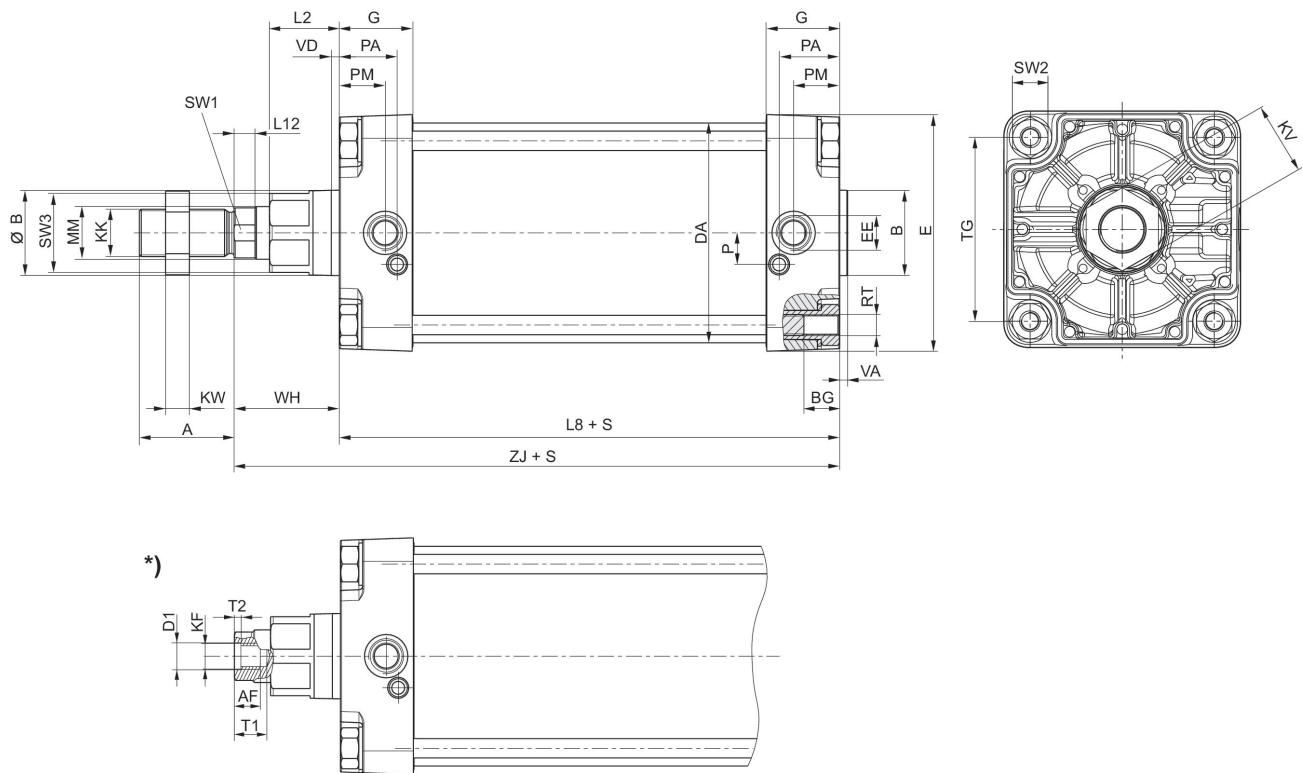

S = stroke

*) For cylinders with optional piston rod with internal thread

Piston Ø	A	B	ØB	BG	DA	E	EE	G	KK
160	72	65	65	24	167	180	G 3/4	56	M36x2
200	72	75	75	24	210	220	G 3/4	54	M36x2
250	84	90	90	25	262	280	G 1	59.5	M42x2
320	96	110	110	28	336	350	G 1	61.5	M48x2

Piston Ø	KV	KW	L2	L8	L12	MM	P	PA	PM
160	55	18	53	180	16	40	24	45	35
200	55	18	56	180	16	40	22.5	42	30
250	65	21	67	200	20	50	29	46	32.8
320	75	24	76	220	23.25	63	30	48	37

Piston Ø	RT	SW1	SW2	SW3	TG	VA	VD	WH	ZJ
160	M16	36	27	60	140	6	6	80	260
200	M16	36	27	60	175	6	6	95	275
250	M20	46	41	80	220	10	31	105	305.3
320	M24	55	50	95	270	10	34	120	340.5

Cushioning diagram

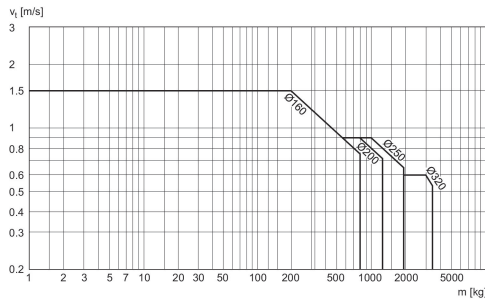

v_1 = Piston velocity [m/s] m = Cushionable mass [kg]

Tie rod cylinder ISO 15552, Series ITS

R480627386

series ITS

2024-04-05

Overview drawing



NOTE: This overview drawing is only for orientation to indicate where the various accessory parts can be fastened to the cylinder. The illustration has been simplified for this purpose. It is thus not possible to derive the dimensions from this overview.