

AVENTICS Series ITS Tie rod cylinders (ISO 15552)

The AVENTICS Series ITS (ISO 15552) cylinders are often chosen when extremely large loads need to be moved efficiently and under control with the familiar ease of operation. The Series ITS (ISO 15552) cylinders are easily configurable to your application needs.

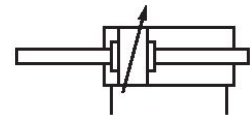

Technical data

Industry	Industrial
Standards	ISO 15552
Piston Ø	320 mm
Stroke	80 mm
Ports	G 1
Functional principle	Double-acting
Cushioning	Pneumatic adjustable cushioning
Magnetic piston	Piston without magnet
Environmental requirements	Industry standard ATEX optional
Piston rod thread - type	External thread
Piston rod thread	M48x2
Piston rod	through
Scraper	Standard Industry Scraper
Pressure for determining piston forces	6,3 bar
Retracting piston force	48704 N
Extracting piston force	48704 N
Min. ambient temperature	-20 °C
Max. ambient temperature	80 °C
Min. working pressure	2 bar
Max. working pressure	10 bar
Cushioning length	56 mm
Cushioning energy	190 J
Weight 0 mm stroke	51.23 kg

Tie rod cylinder ISO 15552, Series ITS

R480627753

series ITS

2024-04-05

Weight +10 mm stroke	1.22 kg
Stroke max.	1000 mm
Medium	Compressed air
Min. medium temperature	-20 °C
Max. medium temperature	80 °C
Max. particle size	50 µm
Min. oil content of compressed air	0 mg/m ³
Max. oil content of compressed air	5 mg/m ³

Material

Piston rod	Stainless Steel
Scraper material	Acrylonitrile butadiene rubber
Material tie-rod	Stainless Steel
Seal material	Acrylonitrile butadiene rubber
Material, front cover	Die-cast aluminum
Cylinder tube	Aluminum
End cover	Die-cast aluminum
Nut for piston rod	Steel, chrome-plated
Part No.	R480627753

Technical information

ATEX-certified cylinders with identification II 2G Ex h IIC T4 Gb / II 2D Ex h IIIC T135°C Db_X can be generated in the Internet configurator.

The operating temperature range for ATEX-certified cylinders is -20°C ... 60°C.

The pressure dew point must be at least 15 °C less than ambient and medium temperature and may not exceed 3 °C.

The oil content of compressed air must remain constant during the life cycle.

Use only the approved oils from AVENTICS. Further information can be found in the "Technical information" document (available in <https://www.emerson.com/en-us/support>).

Tie rod cylinder ISO 15552, Series ITS

R480627753

series ITS

2024-04-05

Dimensions

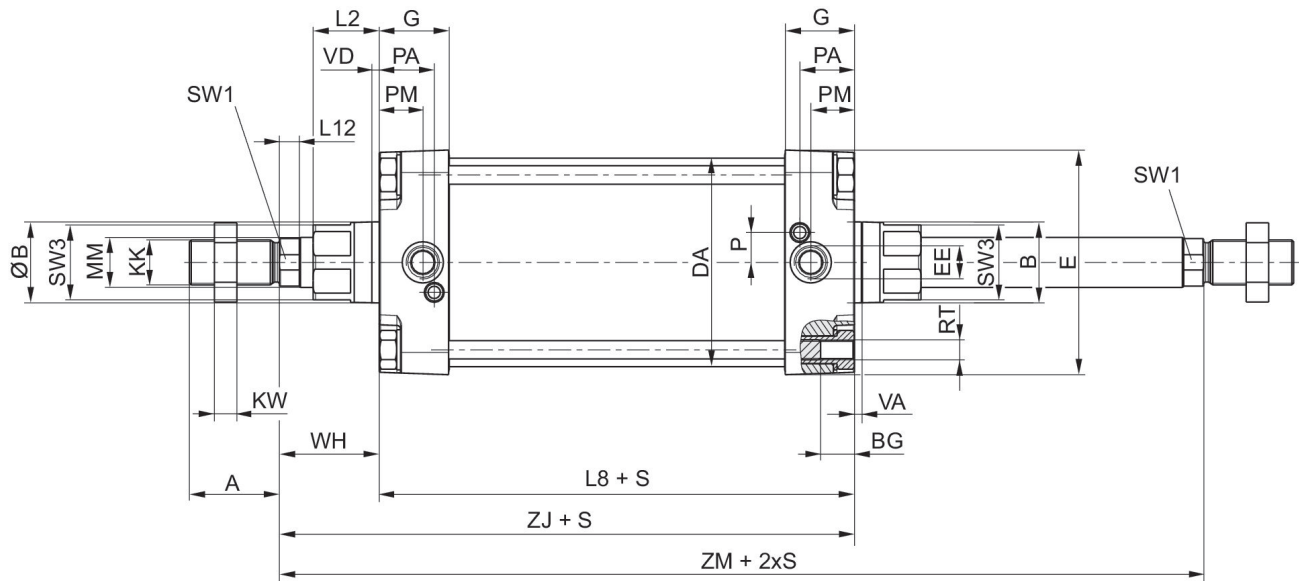

S = stroke

Piston Ø	A	B	ØB	BG	DA	E	EE	G	KK
160	72	65	65	24	167	180	G 3/4	56	M36x2
200	72	75	75	24	210	220	G 3/4	54	M36x2
250	84	90	90	25	262	280	G 1	59.5	M42x2
320	96	110	110	28	336	350	G 1	61.5	M48x2

Piston Ø	KV	KW	L2	L8	L12	MM	P	PA	PM
160	55	18	53	180	16	40	24	45	35
200	55	18	56	180	16	40	22.5	42	30
250	65	21	67	200	20	50	29	46	32.8
320	75	24	76	220	23.25	63	30	48	37

Tie rod cylinder ISO 1552, Series ITS

R480627753

series ITS

2024-04-05

Piston Ø	RT	SW1	SW2	SW3	TG	VD	WH	ZJ	ZM
160	M16	36	27	60	140	6	80	260	340
200	M16	36	27	60	175	6	95	275	370
250	M20	46	41	80	220	31	105	305.3	411
320	M24	55	50	95	270	34	120	340.5	462

Cushioning diagram



v_i = Piston velocity [m/s] m = Cushionable mass [kg]

Tie rod cylinder ISO 1552, Series ITS

R480627753

series ITS

2024-04-05

Overview drawing



NOTE: This overview drawing is only for orientation to indicate where the various accessory parts can be fastened to the cylinder. The illustration has been simplified for this purpose. It is thus not possible to derive the dimensions from this overview.