

AVENTICS Series ITS Tie rod cylinders (ISO 15552)

The AVENTICS Series ITS (ISO 15552) cylinders are often chosen when extremely large loads need to be moved efficiently and under control with the familiar ease of operation. The Series ITS (ISO 15552) cylinders are easily configurable to your application needs.

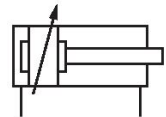
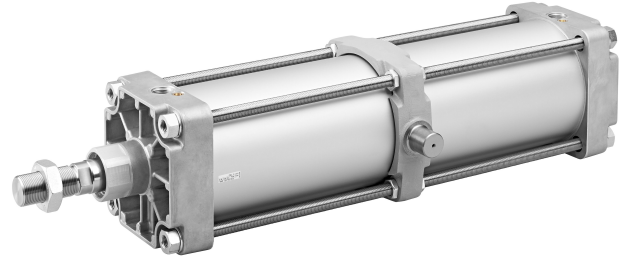

Technical data

| | |
|--|------------------------------------|
| Industry | Industrial |
| Standards | ISO 15552 |
| Piston Ø | 320 mm |
| Stroke | 320 mm |
| Ports | G 1 |
| Functional principle | Double-acting |
| Cushioning | Pneumatic adjustable cushioning |
| Magnetic piston | Piston without magnet |
| Environmental requirements | Industry standard ATEX optional |
| Piston rod thread - type | External thread |
| Piston rod thread | M48x2 |
| Piston rod | single |
| Cylinder special features | with trunnion mounting |
| Scraper | Standard Industry Scraper |
| Pressure for determining piston forces | 6,3 bar |
| Retracting piston force | 48704 N |
| Extracting piston force | 50668 N |
| Min. ambient temperature | -20 °C |
| Max. ambient temperature | 80 °C |

| | |
|------------------------------------|---------------------|
| Min. working pressure | 2 bar |
| Max. working pressure | 10 bar |
| Cushioning length | 56 mm |
| Cushioning energy | 190 J |
| Weight 0 mm stroke | 82.49 kg |
| Weight +10 mm stroke | 0.61 kg |
| Stroke max. | 2500 mm |
| Medium | Compressed air |
| Min. medium temperature | -20 °C |
| Max. medium temperature | 80 °C |
| Max. particle size | 50 µm |
| Min. oil content of compressed air | 0 mg/m ³ |
| Max. oil content of compressed air | 5 mg/m ³ |

Material

| | |
|-----------------------|--------------------------------|
| Piston rod | Stainless Steel |
| Scraper material | Acrylonitrile butadiene rubber |
| Material tie-rod | Stainless Steel |
| Seal material | Acrylonitrile butadiene rubber |
| Material, front cover | Die-cast aluminum |
| Cylinder tube | Aluminum |
| End cover | Die-cast aluminum |
| Nut for piston rod | Steel, chrome-plated |
| Trunnion mounting | Nodular graphite iron |
| Part No. | R480627531 |

Technical information

The trunnion mounting is positioned in the center at the factory and can be adjusted later.

ATEX-certified cylinders with identification II 2G Ex h IIC T4 Gb / II 2D Ex h IIIC T135°C Db_X can be generated in the Internet configurator.

The operating temperature range for ATEX-certified cylinders is -20°C ... 60°C.

The pressure dew point must be at least 15 °C less than ambient and medium temperature and may not exceed 3 °C.

The oil content of compressed air must remain constant during the life cycle.

Use only the approved oils from AVENTICS. Further information can be found in the "Technical information" document (available in <https://www.emerson.com/en-us/support>).

Dimensions

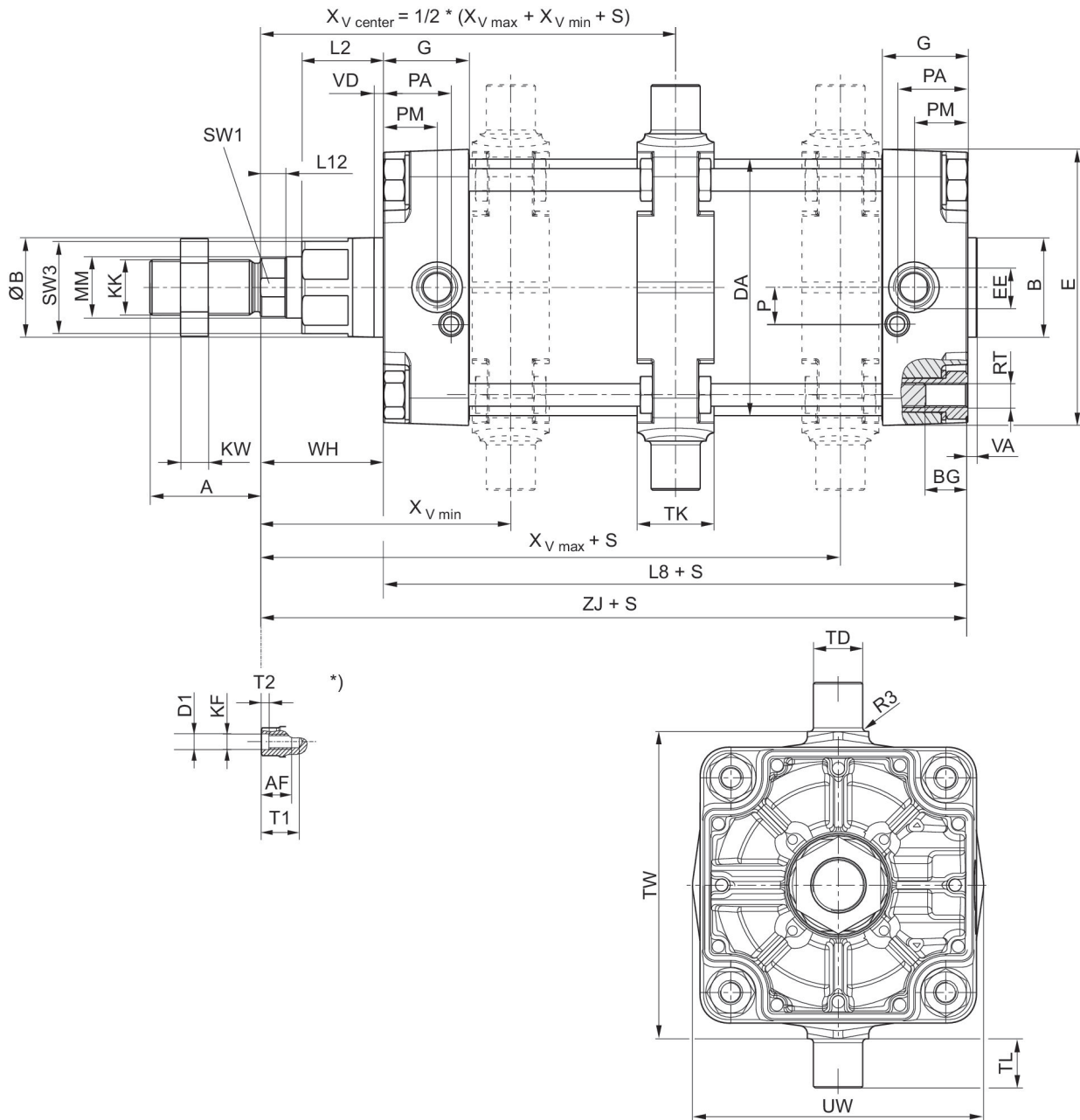

S = stroke

*) For cylinders with optional piston rod with internal thread

| Piston Ø | A | B | ØB | BG | DA | E | EE | G | KK |
|----------|----|-----|-----|----|-----|-----|-------|------|-------|
| 160 | 72 | 65 | 65 | 24 | 167 | 180 | G 3/4 | 56 | M36x2 |
| 200 | 72 | 75 | 75 | 24 | 210 | 220 | G 3/4 | 54 | M36x2 |
| 250 | 84 | 90 | 90 | 25 | 262 | 280 | G 1 | 59.5 | M42x2 |
| 320 | 96 | 110 | 110 | 28 | 336 | 350 | G 1 | 61.5 | M48x2 |

Tie rod cylinder ISO 15552, Series ITS

R480627531

series ITS

2024-04-05

| Piston Ø | KV | KW | L2 | L8 | L12 | MM | P | PA | PM |
|----------|----|----|----|-----|-------|----|------|----|------|
| 160 | 55 | 18 | 53 | 180 | 16 | 40 | 24 | 45 | 35 |
| 200 | 55 | 18 | 56 | 180 | 16 | 40 | 22.5 | 42 | 30 |
| 250 | 65 | 21 | 67 | 200 | 20 | 50 | 29 | 46 | 32.8 |
| 320 | 75 | 24 | 76 | 220 | 23.25 | 63 | 30 | 48 | 37 |

| Piston Ø | R3 | RT | SW1 | SW2 | SW3 | TD e9 | TG | TK | TL h14 |
|----------|-----|-----|-----|-----|-----|-------|-----|----|--------|
| 160 | 2.5 | M16 | 36 | 27 | 60 | 32 | 140 | 50 | 32 |
| 200 | 2.5 | M16 | 36 | 27 | 60 | 32 | 175 | 50 | 32 |
| 250 | 3 | M20 | 46 | 41 | 80 | 40 | 220 | 60 | 40 |
| 320 | 3.2 | M24 | 55 | 50 | 95 | 50 | 270 | 70 | 50 |

| Piston Ø | TW h14 | UW | VD | WH | XV min | XV max | ZJ |
|----------|--------|-----|----|-----|--------|--------|-------|
| 160 | 200 | 190 | 6 | 80 | 163 | 177 | 260 |
| 200 | 250 | 240 | 6 | 95 | 177 | 193 | 275 |
| 250 | 320 | 310 | 31 | 105 | 195 | 215 | 305.3 |
| 320 | 400 | 400 | 34 | 120 | 228 | 233 | 340.5 |

Cushioning diagram

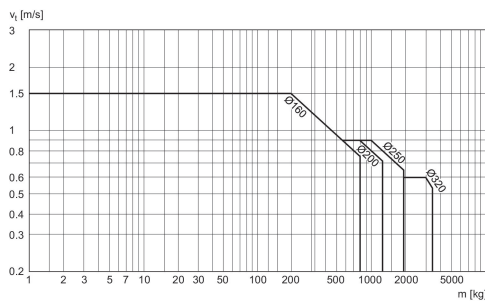

v_t = Piston velocity [m/s] m = Cushionable mass [kg]

Tie rod cylinder ISO 1552, Series ITS

R480627531

series ITS

2024-04-05

Overview drawing



NOTE: This overview drawing is only for orientation to indicate where the various accessory parts can be fastened to the cylinder. The illustration has been simplified for this purpose. It is thus not possible to derive the dimensions from this overview.