

# Short-stroke cylinder, Series KHZ

0822010666

AVENTICS  
Series KHZ  
Short-stroke  
cylinders

2024-04-09

## AVENTICS Series KHZ Short-stroke cylinders

The AVENTICS Series KHZ is a non-standard short-stroke cylinder ideal for tight installation spaces and ensure easy, safe integration in machinery.

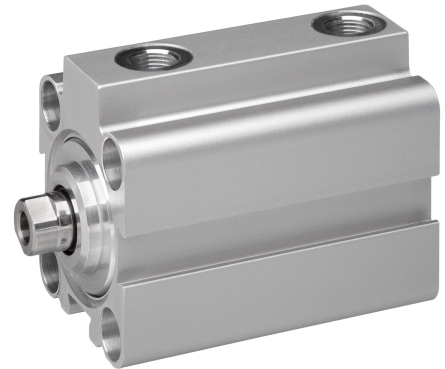

### Technical data

|  |                           |
|--|---------------------------|
| Industry                               | Industrial                |
| Piston Ø                               | 50 mm                     |
| Stroke                                 | 40 mm                     |
| Ports                                  | G 1/8                     |
| Functional principle                   | Double-acting             |
| Cushioning                             | Elastic cushioning        |
| Magnetic piston                        | Piston with magnet        |
| Environmental requirements             | Industry standard         |
| Piston rod thread - type               | Internal thread           |
| Piston rod thread                      | M8                        |
| Piston rod                             | single                    |
| Scraper                                | Standard Industry Scraper |
| Pressure for determining piston forces | 6,3 bar                   |
| Retracting piston force                | 1110 N                    |
| Extracting piston force                | 1237 N                    |
| Min. ambient temperature               | -25 °C                    |
| Max. ambient temperature               | 80 °C                     |
| Min. working pressure                  | 0.6 bar                   |
| Max. working pressure                  | 10 bar                    |
| Impact energy                          | 0.32 J                    |
| Weight 0 mm stroke                     | 0.388 kg                  |
| Weight +10 mm stroke                   | 0.074 kg                  |
| Medium                                 | Compressed air            |
| Min. medium temperature                | -25 °C                    |

# Short-stroke cylinder, Series KHZ

0822010666

AVENTICS  
Series KHZ  
Short-stroke  
cylinders

2024-04-09

|                                    |                     |
|------------------------------------|---------------------|
| Max. medium temperature            | 80 °C               |
| Max. particle size                 | 50 µm               |
| Min. oil content of compressed air | 0 mg/m <sup>3</sup> |
| Max. oil content of compressed air | 5 mg/m <sup>3</sup> |

## Material

|                       |                 |
|-----------------------|-----------------|
| Piston rod            | Stainless Steel |
| Piston material       | Nitrile rubber  |
| Scraper material      | Polyurethane    |
| Material, front cover | Aluminum        |
| Cylinder tube         | Aluminum        |
| End cover             | Aluminum        |
| Part No.              | 0822010666      |

## Technical information

Other versions can be ordered from AVENTICS sales offices.

The pressure dew point must be at least 15 °C less than ambient and medium temperature and may not exceed 3 °C.

The oil content of compressed air must remain constant during the life cycle.

Use only the approved oils from AVENTICS. Further information can be found in the "Technical information" document (available in <https://www.emerson.com/en-us/support>).

# Short-stroke cylinder, Series KHZ

0822010666

AVENTICS  
Series KHZ  
Short-stroke  
cylinders

2024-04-09

## Dimensions

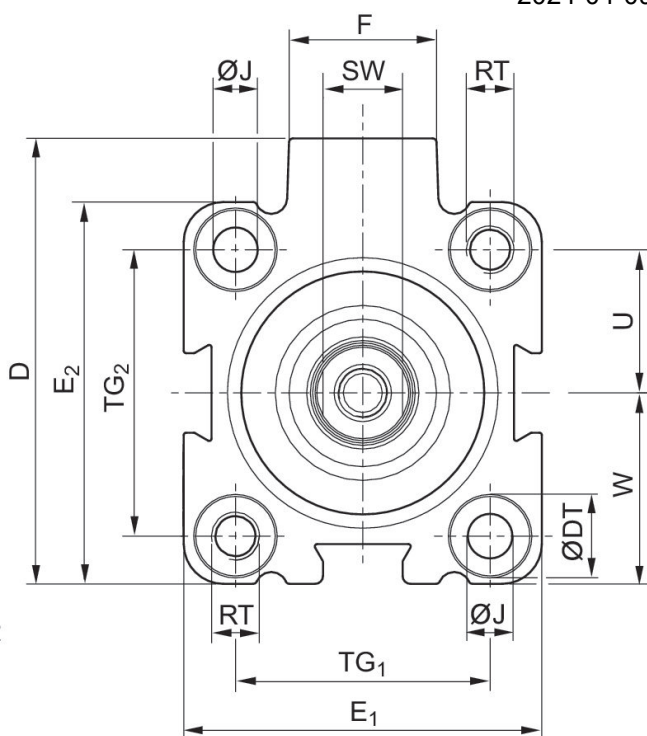
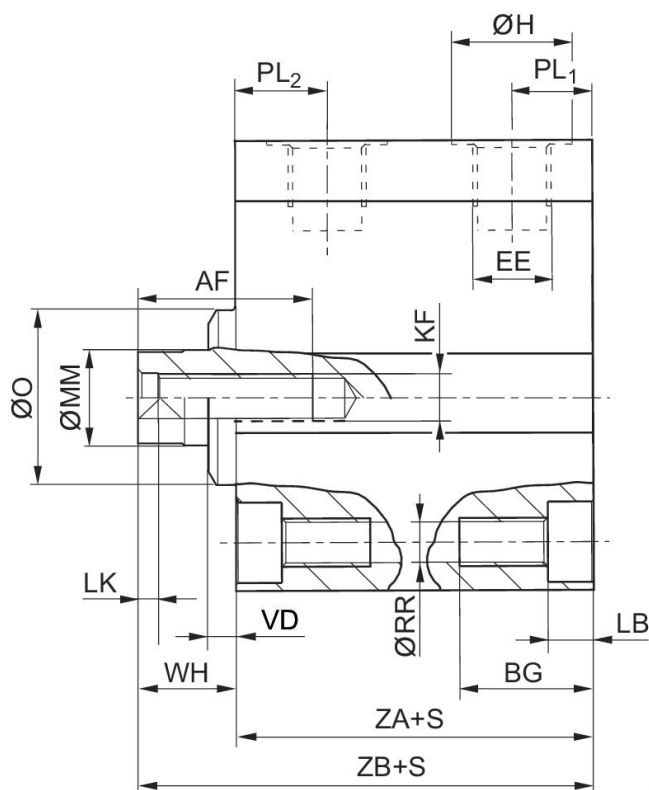

**Ø16-Ø100**

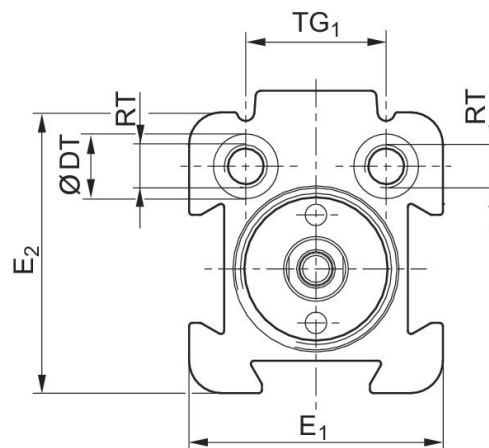
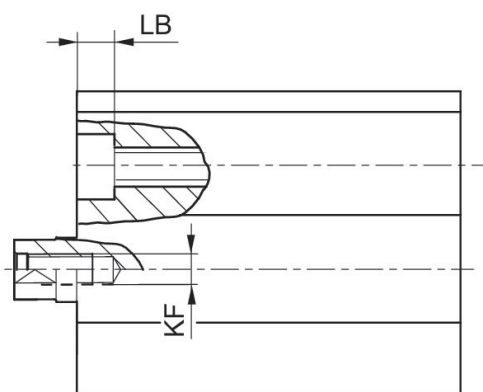

**Ø12**

S = stroke

| Piston Ø | Stroke  | AF +1 | BG min. | D JS15 | ØDT H13 | E1 JS15 | E2 JS15 | EE    | F    |
|----------|---------|-------|---------|--------|---------|---------|---------|-------|------|
| 12       | 5 - 10  | 8     | 12.4    | 28     | 6       | 23.5    | 26      | M 5   | 11   |
| 16       | 5 - 10  | 10    | 12.4    | 33     | 6       | 28      | 28      | M 5   | 11.5 |
| 20       | 5 - 10  | 10    | 13.6    | 37     | 7.5     | 32      | 32      | M 5   | 11   |
| 25       | 5 - 50  | 10    | 13.6    | 47.5   | 8       | 37      | 39      | G 1/8 | 17.5 |
| 32       | 5 - 100 | 15    | 16.7    | 56     | 10      | 45      | 48      | G 1/8 | 18.5 |

# Short-stroke cylinder, Series KHZ

0822010666

AVENTICS  
Series KHZ  
Short-stroke  
cylinders

| Piston Ø | Stroke   | AF +1 | BG min. | D JS15 | ØDT H13 | E1 JS15 | E2 JS15 | EE    | F    |
|----------|----------|-------|---------|--------|---------|---------|---------|-------|------|
| 40       | 5 - 100  | 15    | 16.7    | 62.5   | 10      | 54.5    | 54      | G 1/8 | 18.5 |
| 50       | 10 - 100 | 18    | 19.8    | 73     | 11      | 66      | 66      | G 1/8 | 18   |
| 63       | 10 - 100 | 18    | 25      | 88     | 15      | 80      | 80      | G 1/8 | 23   |
| 80       | 10 - 100 | 18    | 25      | 110    | 15      | 100     | 100     | G 1/4 | 27   |
| 100      | 10 - 100 | 20    | 30      | 132    | 17.5    | 124     | 124     | G 1/4 | 28   |

| Piston Ø | ØH | ØJ   | KF  | LB +0,4 | LK +0,5 | ØMM f8 | ØO | PL1  | PL2  |
|----------|----|------|-----|---------|---------|--------|----|------|------|
| 12       | 8  | 3.3  | M3  | 3.4     | 2       | 6      | –  | 6    | 10.5 |
| 16       | 8  | 3.55 | M5  | 3.4     | 2       | 8      | –  | 6.5  | 11.3 |
| 20       | 8  | 4.55 | M5  | 4.6     | 2       | 10     | –  | 6.5  | 10   |
| 25       | 15 | 4.55 | M5  | 4.6     | 2       | 10     | 20 | 9.5  | 11.5 |
| 32       | 15 | 5.5  | M6  | 5.7     | 2.5     | 12     | 22 | 8.5  | 15   |
| 40       | 15 | 5.5  | M6  | 5.7     | 2.5     | 12     | 30 | 10   | 13.5 |
| 50       | 15 | 7.3  | M8  | 6.8     | 3.5     | 16     | 35 | 10   | 14   |
| 63       | 15 | 9.2  | M8  | 9       | 3.5     | 16     | 35 | 11.5 | 14   |
| 80       | 19 | 9.2  | M10 | 9       | 4       | 20     | 46 | 12   | 15.5 |
| 100      | 19 | 11   | M12 | 11      | 4       | 25     | 56 | 12   | 18.5 |

| Piston Ø | ØRR  | RT  | SW -0,3 | TG1      | TG2      | U    | W         | VD -1 | WH   |
|----------|------|-----|---------|----------|----------|------|-----------|-------|------|
| 12       | 3.3  | M4  | 5       | 13 ±0,2  | –        | 9.5  | 11,5 ±0,2 | –     | 5.5  |
| 16       | 3.3  | M4  | 7       | 20 ±0,2  | 20 ±0,2  | 10   | 14 ±0,2   | –     | 4.5  |
| 20       | 4.2  | M5  | 8       | 22 ±0,2  | 22 ±0,2  | 11   | 16 ±0,2   | –     | 4.5  |
| 25       | 4.2  | M5  | 8       | 26 ±0,25 | 28 ±0,25 | 14   | 19,5 ±0,2 | 3.5   | 9.5  |
| 32       | 5.05 | M6  | 10      | 32 ±0,25 | 36 ±0,25 | 18   | 24 ±0,2   | 3.5   | 11   |
| 40       | 5.05 | M6  | 10      | 40 ±0,25 | 40 ±0,25 | 20   | 27,3 ±0,2 | 4.5   | 13.5 |
| 50       | 6.8  | M8  | 13      | 50 ±0,25 | 50 ±0,25 | 25   | 33 ±0,2   | 6     | 13.5 |
| 63       | 8.5  | M10 | 13      | 62 ±0,25 | 62 ±0,25 | 31   | 40 ±0,2   | 6.5   | 15.5 |
| 80       | 8.5  | M10 | 17      | 82 ±0,3  | 82 ±0,3  | 41   | 50 ±0,3   | 8.5   | 18   |
| 100      | 10.2 | M12 | 22      | 103 ±0,3 | 103 ±0,3 | 51.5 | 62 ±0,3   | 7     | 20   |

| Piston Ø | ZA ±0,2 | ZB ±0,8 |
|----------|---------|---------|
| 12       | 30.5    | 36      |
| 16       | 32      | 36.5    |
| 20       | 32      | 36.5    |
| 25       | 39      | 48.5    |
| 32       | 39.5    | 50.5    |
| 40       | 39.5    | 53      |
| 50       | 39.5    | 53      |
| 63       | 42      | 57.5    |
| 80       | 46      | 64      |
| 100      | 56      | 76      |

# Short-stroke cylinder, Series KHZ

0822010666

AVENTICS  
Series KHZ  
Short-stroke  
cylinders

2024-04-09

## Overview drawing



NOTE: This overview drawing is only for orientation to indicate where the various accessory parts can be fastened to the cylinder. The illustration has been simplified for this purpose. It is thus not possible to derive the dimensions from this overview.