

# Short-stroke cylinder, Series KHZ

0822010887

AVENTICS  
Series KHZ  
Short-stroke  
cylinders

2024-04-09

## AVENTICS Series KHZ Short-stroke cylinders

The AVENTICS Series KHZ is a non-standard short-stroke cylinder ideal for tight installation spaces and ensure easy, safe integration in machinery.



### Technical data

Industry	Industrial
Piston Ø	80 mm
Stroke	50 mm
Ports	G 1/4
Functional principle	Double-acting
Cushioning	Elastic cushioning
Magnetic piston	Piston with magnet
Environmental requirements	Industry standard
Piston rod thread - type	Internal thread
Piston rod	non-rotating
Scraper	Standard Industry Scraper
Pressure for determining piston forces	6,3 bar
Retracting piston force	2857 N
Extracting piston force	3167 N
Min. ambient temperature	-25 °C
Max. ambient temperature	80 °C
Min. working pressure	0.6 bar
Max. working pressure	10 bar
Impact energy	0.38 J
Weight 0 mm stroke	1.22 kg
Weight +10 mm stroke	0.167 kg
Medium	Compressed air
Min. medium temperature	-25 °C

# Short-stroke cylinder, Series KHZ

0822010887

AVENTICS  
Series KHZ  
Short-stroke  
cylinders

2024-04-09

Max. medium temperature	80 °C
Max. particle size	50 µm
Min. oil content of compressed air	0 mg/m <sup>3</sup>
Max. oil content of compressed air	5 mg/m <sup>3</sup>

## Material

Piston rod	Stainless Steel
Piston material	Nitrile rubber
Scraper material	Polyurethane
Material, front cover	Aluminum
Cylinder tube	Aluminum
End cover	Aluminum
Part No.	0822010887

## Technical information

Other versions can be ordered from AVENTICS sales offices.

The pressure dew point must be at least 15 °C less than ambient and medium temperature and may not exceed 3 °C.

The oil content of compressed air must remain constant during the life cycle.

Use only the approved oils from AVENTICS. Further information can be found in the "Technical information" document (available in <https://www.emerson.com/en-us/support>).

# Short-stroke cylinder, Series KHZ

0822010887

AVENTICS  
Series KHZ  
Short-stroke  
cylinders

2024-04-09

## Dimensions

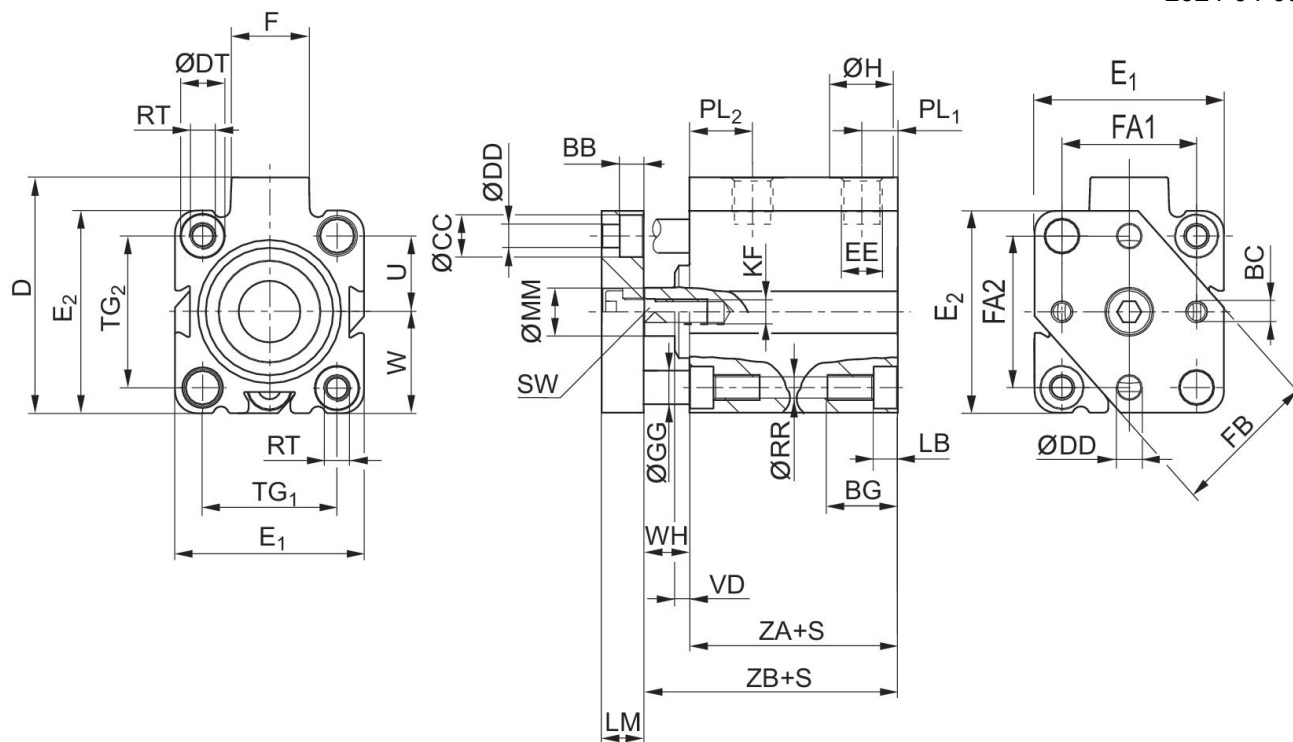

Piston Ø	Stroke	BB	BC	BG min.	ØCC	D JS15	ØDD	ØDT H13	E1 JS15
16	10	3.5	M3	12.4	6	33	3.5	6	28
20	10	5	M4	13.6	7.5	37	4.5	7.5	32
16	15 - 50	3.5	M3	17.5	6	33	3.5	6	28
20	15 - 50	5	M4	13.6	7.5	37	4.5	7.5	32
25	10 - 50	5	M4	13.6	8	47.5	4.5	8	37
32	10 - 100	5.7	M5	16.7	10	56	5.5	10	45
40	10 - 100	5.7	M5	16.7	10	62.5	5.5	10	54.5
50	10 - 100	6.8	M6	19.8	11	73	6.5	11	66
63	10 - 100	9	M6	25	14	88	9	15	80
80	10/25/50 /80/100	9	M8	25	14	110	9	15	100
100	10/25/50 /80/100	9	M8	30	14	132	9	17.5	124

Piston Ø	E2 JS15	EE	F	FB	ØGG -0,005/-0,025	ØH	KF	LB +0,4	LM
16	28	M5	11.5	20	4	8	M5	3.4	6
20	32	M5	11	25	5	8	M5	4.6	8
16	28	M5	11.5	20	4	8	M5	8.5	6
20	32	M5	11	25	5	8	M5	4.6	8
25	39	G 1/8	17.5	30	6	15	M5	4.6	8
32	48	G 1/8	18.5	35	8	15	M6	5.7	10
40	54.5	G 1/8	18.5	40	8	15	M6	5.7	10
50	66	G 1/8	18	50	10	15	M8	6.8	12

# Short-stroke cylinder, Series KHZ

0822010887

AVENTICS  
Series KHZ  
Short-stroke  
cylinders

Piston Ø	E2 JS15	EE	F	FB	ØGG -0,005/-0,025	ØH	KF	LB +0,4	LM
63	80	G 1/8	23	60	12	15	M 8	9	12
80	100	G 1/4	27	75	12	19	M 10	9	15
100	124	G 1/4	28	90	14	19	M 12	11	15

Piston Ø	ØMM f8	PL1	PL2	ØRR	RT	SW -0,3	TG1	TG2	U
16	8	6.5	11.3	3.3	M4	7	20 ±0,2	20 ±0,2	10
20	10	6.5	10	4.2	M5	8	22 ±0,2	22 ±0,2	11
16	8	6.5	11.3	3.3	M4	7	20 ±0,2	20 ±0,2	10
20	10	6.5	10	4.2	M5	8	22 ±0,2	22 ±0,2	11
25	10	9.5	11.5	4.2	M5	8	26 ±0,25	28 ±0,25	14
32	12	8.5	15	5.05	M6	10	32 ±0,25	36 ±0,25	18
40	12	10	13.5	5.05	M6	10	40 ±0,25	40 ±0,25	20
50	16	10	14	6.8	M8	13	50 ±0,25	50 ±0,25	25
63	16	11.5	14	8.5	M10	13	62 ±0,25	62 ±0,25	31
80	20	12	15.5	8.5	M10	17	82 ±0,3	82 ±0,3	41
100	25	12	18.5	10.2	M12	22	103 ±0,3	103 ±0,3	51.5

Piston Ø	VD -1	W	WH	FA1 ±0,1	FA2 ±0,1	ZA ±0,2	ZB ±0,8
16	–	14 ±0,2	4.5	20	20	32	36.5
20	–	16 ±0,2	4.5	22	22	32	36.5
16	–	14 ±0,2	4.5	20	20	38	42.5
20	–	16 ±0,2	4.5	22	22	38	42.5
25	3.5	19,5 ±0,2	9.5	26	28	39	48.5
32	3.5	24 ±0,2	11	32	36	39.5	50.5
40	4.5	27,3 ±0,2	13.5	40	40	39.5	53
50	6	33 ±0,2	13.5	50	50	39.5	53
63	6.5	40 ±0,2	15.5	62	62	42	57.5
80	8.5	50 ±0,3	18	82	82	46	64
100	7	62 ±0,3	20	103	103	56	76

# Short-stroke cylinder, Series KHZ

0822010887

AVENTICS  
Series KHZ  
Short-stroke  
cylinders

2024-04-09

M = max. permissible torque  
dynamic

Max. permissible torque  
static

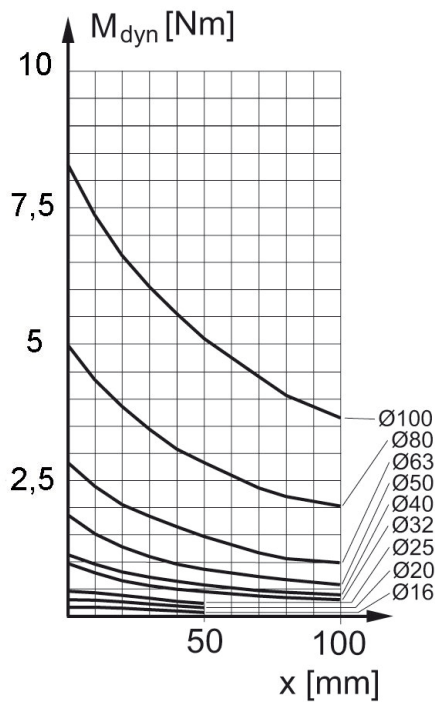

X = distance between force application point and cylinder cover

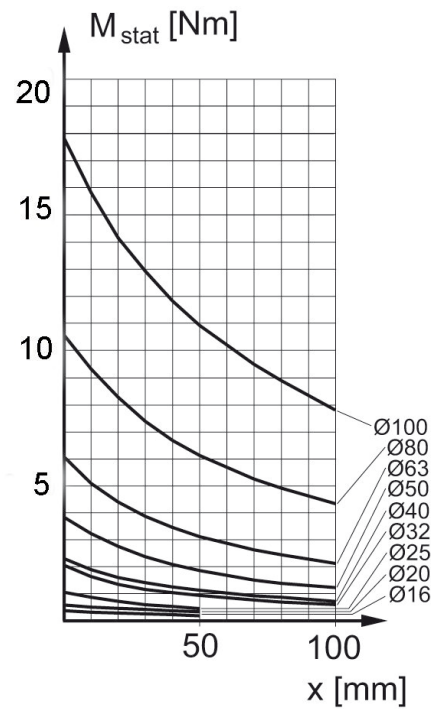

X = distance between force application point and cylinder cover

# Short-stroke cylinder, Series KHZ

0822010887

AVENTICS  
Series KHZ  
Short-stroke  
cylinders  
2024-04-09

Maximum admissible lateral force  
dynamic

Maximum admissible lateral force  
static

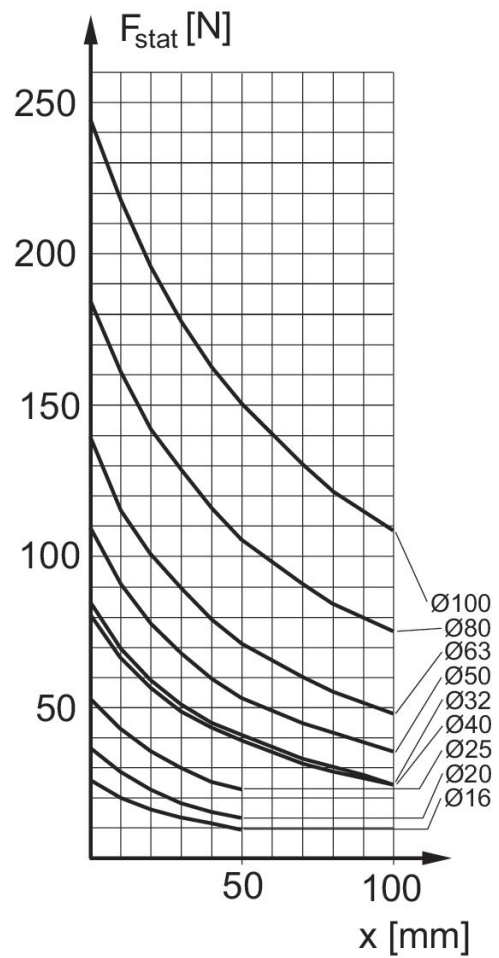
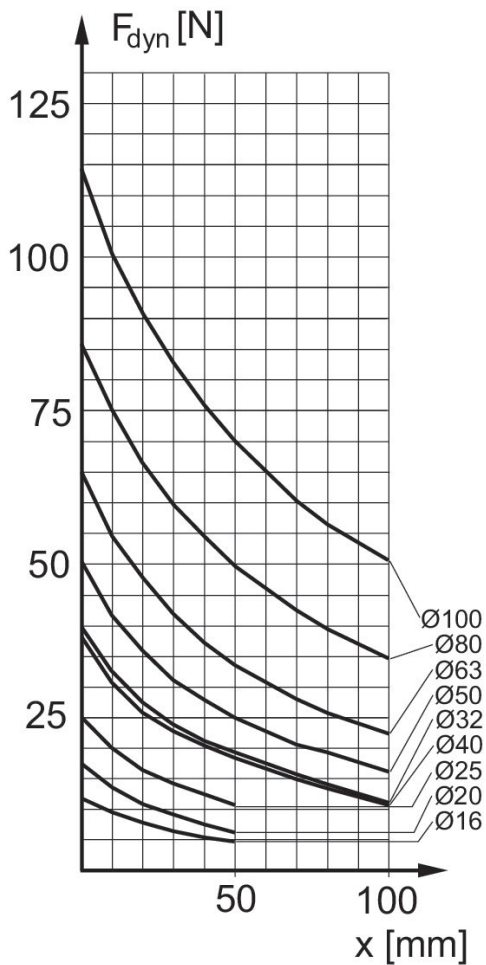

$F_{dyn}$  = dynamic lateral force  
 $X$  = distance between force application point and cylinder cover

$F_{stat}$  = static lateral force  
 $X$  = distance between force application point and cylinder cover

Maximum admissible lateral force  
dynamic

Maximum admissible lateral force  
static



$F_{dyn}$  = dynamic lateral force  
 $X$  = distance between force application point and cylinder cover

$F_{stat}$  = static lateral force  
 $X$  = distance between force application point and cylinder cover

# Short-stroke cylinder, Series KHZ

0822010887

AVENTICS  
Series KHZ  
Short-stroke  
cylinders

2024-04-09

Max. permissible torque  
static

Max. permissible torque  
dynamic

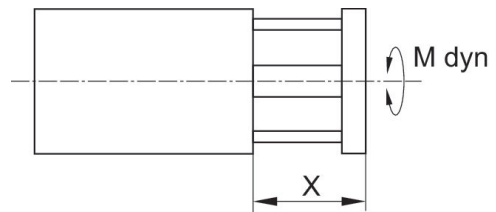

## Overview drawing

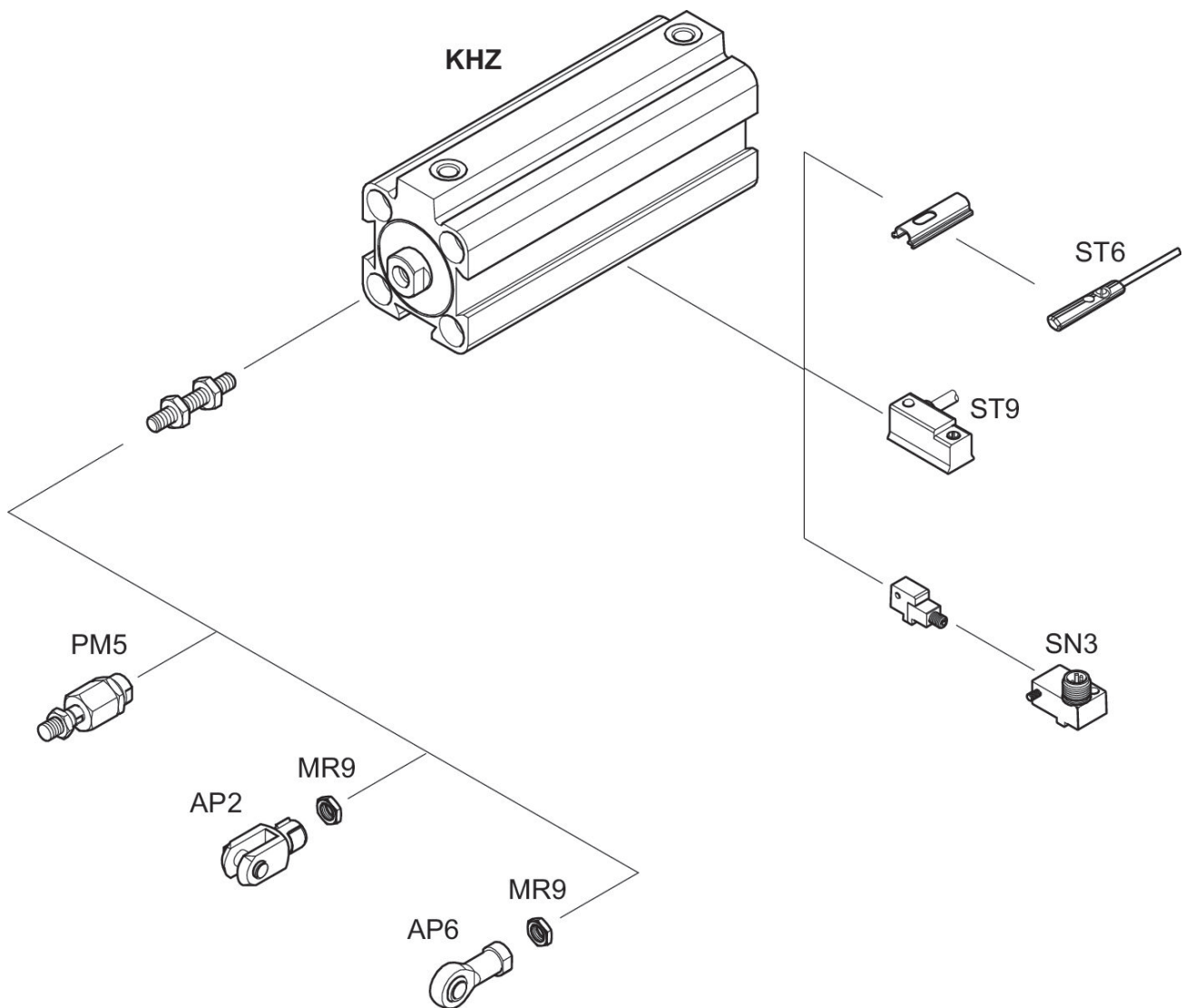

NOTE: This overview drawing is only for orientation to indicate where the various accessory parts can be fastened to the cylinder. The illustration has been simplified for this purpose. It is thus not possible to derive the dimensions from this overview.