

Short-stroke cylinder, Series KHZ

0822406442

AVENTICS
Series KHZ
Short-stroke
cylinders

2024-04-09

AVENTICS Series KHZ Short-stroke cylinders

The AVENTICS Series KHZ is a non-standard short-stroke cylinder ideal for tight installation spaces and ensure easy, safe integration in machinery.



Technical data

Industry	Industrial
Piston Ø	32 mm
Stroke	25 mm
Ports	G 1/8
Functional principle	Single-acting, retracted without pressure
Cushioning	Elastic cushioning
Magnetic piston	Piston with magnet
Environmental requirements	Industry standard
Piston rod thread - type	Internal thread
Piston rod thread	M6
Piston rod	single
Scraper	Standard Industry Scraper
Pressure for determining piston forces	6,3 bar
Retracting piston force	18.5 N
Extracting piston force	507 N
Min. ambient temperature	-25 °C
Max. ambient temperature	80 °C
Min. working pressure	1.3 bar
Max. working pressure	10 bar
Weight	0.226 kg
Medium	Compressed air

Short-stroke cylinder, Series KHZ

0822406442

AVENTICS
Series KHZ
Short-stroke
cylinders

2024-04-09

Min. medium temperature	-25 °C
Max. medium temperature	80 °C
Max. particle size	50 µm
Min. oil content of compressed air	0 mg/m ³
Max. oil content of compressed air	5 mg/m ³

Material

Piston rod	Stainless Steel
Piston material	Nitrile rubber
Material, front cover	Aluminum
Cylinder tube	Aluminum
End cover	Aluminum
Part No.	0822406442

Technical information

The pressure dew point must be at least 15 °C less than ambient and medium temperature and may not exceed 3 °C.

The oil content of compressed air must remain constant during the life cycle.

Use only the approved oils from AVENTICS. Further information can be found in the “Technical information” document (available in <https://www.emerson.com/en-us/support>).

Short-stroke cylinder, Series KHZ

0822406442

AVENTICS
Series KHZ
Short-stroke
cylinders

2024-04-09

Dimensions

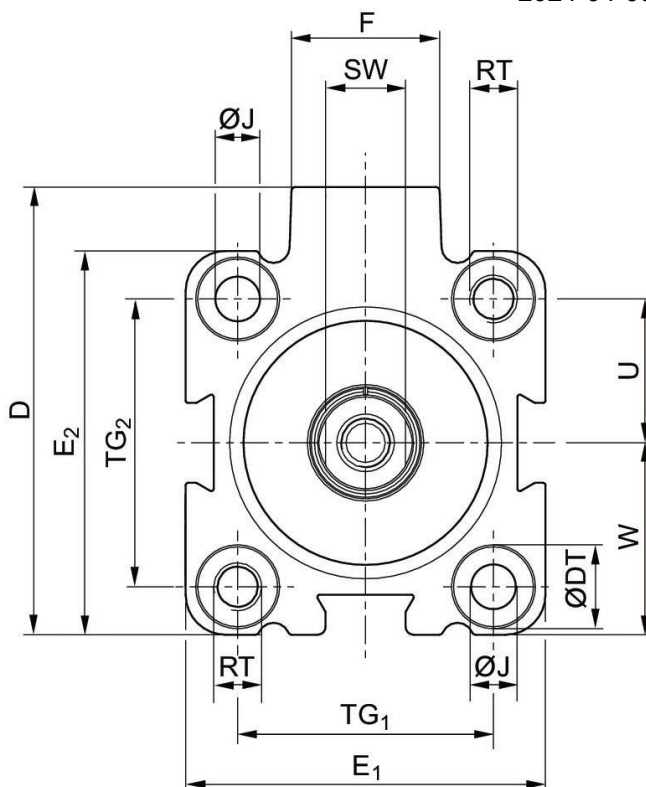
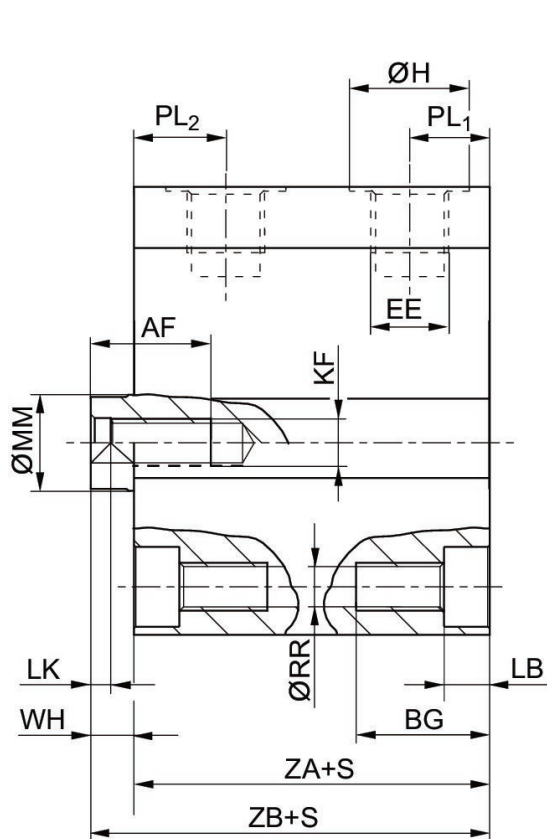

Ø16-Ø100

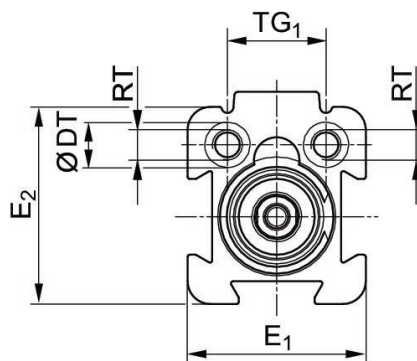
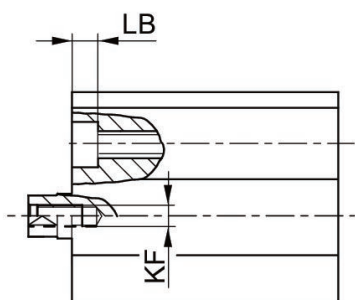

Ø12

S = stroke

Part No.	Piston Ø	S	AF +1	BG min.	D JS15	ØDT H13	E1 JS15	E2 JS15	EE
0822406400	12	4	8	12.4	28	6	23.5	26	M 5
0822406401	12	10	8	12.4	28	6	23.5	26	M 5
0822406410	16	4	10	12.4	33	6	28	28	M 5
0822406411	16	10	10	12.4	33	6	28	28	M 5

Short-stroke cylinder, Series KHZ

0822406442

AVENTICS
Series KHZ
Short-stroke
cylinders

Part No.	Piston Ø	S	AF +1	BG min.	D JS15	ØDT H13	E1 JS15	E2 JS15	EE
0822406412	16	25	10	17.5	33	6	28	28	M 5
0822406420	20	4	10	13.6	37	7.5	32	32	M 5
0822406421	20	10	10	13.6	37	7.5	32	32	M 5
0822406422	20	25	10	13.6	37	7.5	32	32	M 5
0822406430	25	5	10	13.6	47.5	8	37	39	G 1/8
0822406431	25	10	10	13.6	47.5	8	37	39	G 1/8
0822406432	25	25	10	13.6	47.5	8	37	39	G 1/8
0822406440	32	5	15	16.7	56	10	45	48	G 1/8
0822406441	32	10	15	16.7	56	10	45	48	G 1/8
0822406442	32	25	15	16.7	56	10	45	48	G 1/8
0822406450	40	5	15	16.7	62.5	10	54.5	54.5	G 1/8
0822406451	40	10	15	16.7	62.5	10	54.5	54.5	G 1/8
0822406452	40	25	15	16.7	62.5	10	54.5	54.5	G 1/8
0822406461	50	10	18	19.8	73	11	66	66	G 1/8
0822406462	50	25	18	19.8	73	11	66	66	G 1/8
0822406471	63	10	18	25	88	15	80	80	G 1/8
0822406472	63	25	18	25	88	15	80	80	G 1/8
0822406481	80	10	18	25	110	15	100	100	G 1/4
0822406482	80	25	18	25	110	15	100	100	G 1/4
0822406491	100	10	20	30	132	17.5	124	124	G 1/4
0822406492	100	25	20	30	132	17.5	124	124	G 1/4

Part No.	Piston Ø	F	ØH	ØJ H14	KF	LB +0,4	LK +0,5	ØMM f8	PL1
0822406400	12	11	8	-	M 3	3.4	2	6	6
0822406401	12	11	8	-	M 3	3.4	2	6	6
0822406410	16	11.5	8	3.55	M 5	3.4	2	8	6.5
0822406411	16	11.5	8	3.55	M 5	3.4	2	8	6.5
0822406412	16	11.5	8	3.55	M 5	8.5	2	8	6.5
0822406420	20	11	8	4.55	M 5	4.6	2	10	6.5
0822406421	20	11	8	4.55	M 5	4.6	2	10	6.5
0822406422	20	11	8	4.55	M 5	4.6	2	10	6.5
0822406430	25	17.5	15	4.55	M 5	4.6	2	10	9.5
0822406431	25	17.5	15	4.55	M 5	4.6	2	10	9.5
0822406432	25	17.5	15	4.55	M 5	4.6	2	10	9.5
0822406440	32	18.5	15	5.5	M 6	5.7	2.5	12	10
0822406441	32	18.5	15	5.5	M 6	5.7	2.5	12	10
0822406442	32	18.5	15	5.5	M 6	5.7	2.5	12	10
0822406450	40	18.5	15	5.5	M 6	5.7	2.5	12	10
0822406451	40	18.5	15	5.5	M 6	5.7	2.5	12	10
0822406452	40	18.5	15	5.5	M 6	5.7	2.5	12	10
0822406461	50	18	15	7.3	M 8	6.8	3.5	16	10
0822406462	50	18	15	7.3	M 8	6.8	3.5	16	10
0822406471	63	23	15	9.2	M 8	9	3.5	16	11.5
0822406472	63	23	15	9.2	M 8	9	3.5	16	11.5
0822406481	80	27	19	9.2	M 10	9	4	20	12
0822406482	80	27	19	9.2	M 10	9	4	20	12
0822406491	100	28	19	11	M 12	11	4	25	12

Short-stroke cylinder, Series KHZ

0822406442

AVENTICS
Series KHZ
Short-stroke
cylinders

Part No.	Piston Ø	F	ØH	ØJ H14	KF	LB +0,4	LK +0,5	ØMM f8	PL1
0822406492	100	28	19	11	M 12	11	4	25	2024-04-09

Part No.	Piston Ø	PL2	ØRR	RT	SW -0,3	TG1	TG2 ±0,2	U	W
0822406400	12	10.5	3.3	M 4	5	13 ±0,2	–	9.5	11,5 ±0,2
0822406401	12	10.5	3.3	M 4	5	13 ±0,2	–	9.5	11,5 ±0,2
0822406410	16	12.5	3.3	M 4	7	20 ±0,2	20 ±0,2	10	14 ±0,2
0822406411	16	12.5	3.3	M 4	7	20 ±0,2	20 ±0,2	10	14 ±0,2
0822406412	16	12.5	3.3	M 4	7	20 ±0,2	20 ±0,2	10	14 ±0,2
0822406420	20	12	4.2	M 5	8	22 ±0,2	22 ±0,2	11	16 ±0,2
0822406421	20	12	4.2	M 5	8	22 ±0,2	22 ±0,2	11	16 ±0,2
0822406422	20	12	4.2	M 5	8	22 ±0,2	22 ±0,2	11	16 ±0,2
0822406430	25	11.5	4.2	M 5	8	26 ±0,25	28 ±0,25	14	19,5 ±0,2
0822406431	25	11.5	4.2	M 5	8	26 ±0,25	28 ±0,25	14	19,5 ±0,2
0822406432	25	11.5	4.2	M 5	8	26 ±0,25	28 ±0,25	14	19,5 ±0,2
0822406440	32	11.5	5.05	M 6	10	32 ±0,25	36 ±0,25	18	24 ±0,2
0822406441	32	11.5	5.05	M 6	10	32 ±0,25	36 ±0,25	18	24 ±0,2
0822406442	32	11.5	5.05	M 6	10	32 ±0,25	36 ±0,25	18	24 ±0,2
0822406450	40	13.5	5.05	M 6	10	40 ±0,25	40 ±0,25	20	27,3 ±0,2
0822406451	40	13.5	5.05	M 6	10	40 ±0,25	40 ±0,25	20	27,3 ±0,2
0822406452	40	13.5	5.05	M 6	10	40 ±0,25	40 ±0,25	20	27,3 ±0,2
0822406461	50	14	6.8	M 8	13	50 ±0,25	50 ±0,25	25	33 ±0,2
0822406462	50	14	6.8	M 8	13	50 ±0,25	50 ±0,25	25	33 ±0,2
0822406471	63	14	8.5	M 10	13	62 ±0,25	62 ±0,25	31	40 ±0,2
0822406472	63	14	8.5	M 10	13	62 ±0,25	62 ±0,25	31	40 ±0,2
0822406481	80	18	8.5	M 10	17	82 ±0,3	82 ±0,3	41	50 ±0,3
0822406482	80	18	8.5	M 10	17	82 ±0,3	82 ±0,3	41	50 ±0,3
0822406491	100	20.5	10.2	M 12	22	103 ±0,3	103 ±0,3	51.5	62 ±0,3
0822406492	100	20.5	10.2	M 12	22	103 ±0,3	103 ±0,3	51.5	62 ±0,3

Part No.	Piston Ø	WH	ZA ±0,2	ZB ±0,8
0822406400	12	4.5	30.5	35
0822406401	12	4.5	30.5	35
0822406410	16	3	32	35
0822406411	16	3	32	35
0822406412	16	4	38	42
0822406420	20	4.5	32	36.5
0822406421	20	4.5	32	36.5
0822406422	20	4.5	38	42.5
0822406430	25	5	39	44
0822406431	25	5	39	44
0822406432	25	5	39	44
0822406440	32	5.5	39.5	45
0822406441	32	5.5	39.5	45
0822406442	32	5.5	39.5	45
0822406450	40	7	39.5	46.5
0822406451	40	7	39.5	46.5
0822406452	40	7	39.5	46.5

Short-stroke cylinder, Series KHZ

0822406442

AVENTICS
Series KHZ
Short-stroke
cylinders

2024-04-09

Part No.	Piston Ø	WH	ZA ±0,2	ZB ±0,8
0822406461	50	7.5	39.5	47
0822406462	50	7.5	39.5	47
0822406471	63	6.5	42	48.5
0822406472	63	6.5	42	48.5
0822406481	80	8	46	54
0822406482	80	8	46	54
0822406491	100	10	56	66
0822406492	100	10	56	66

Overview drawing

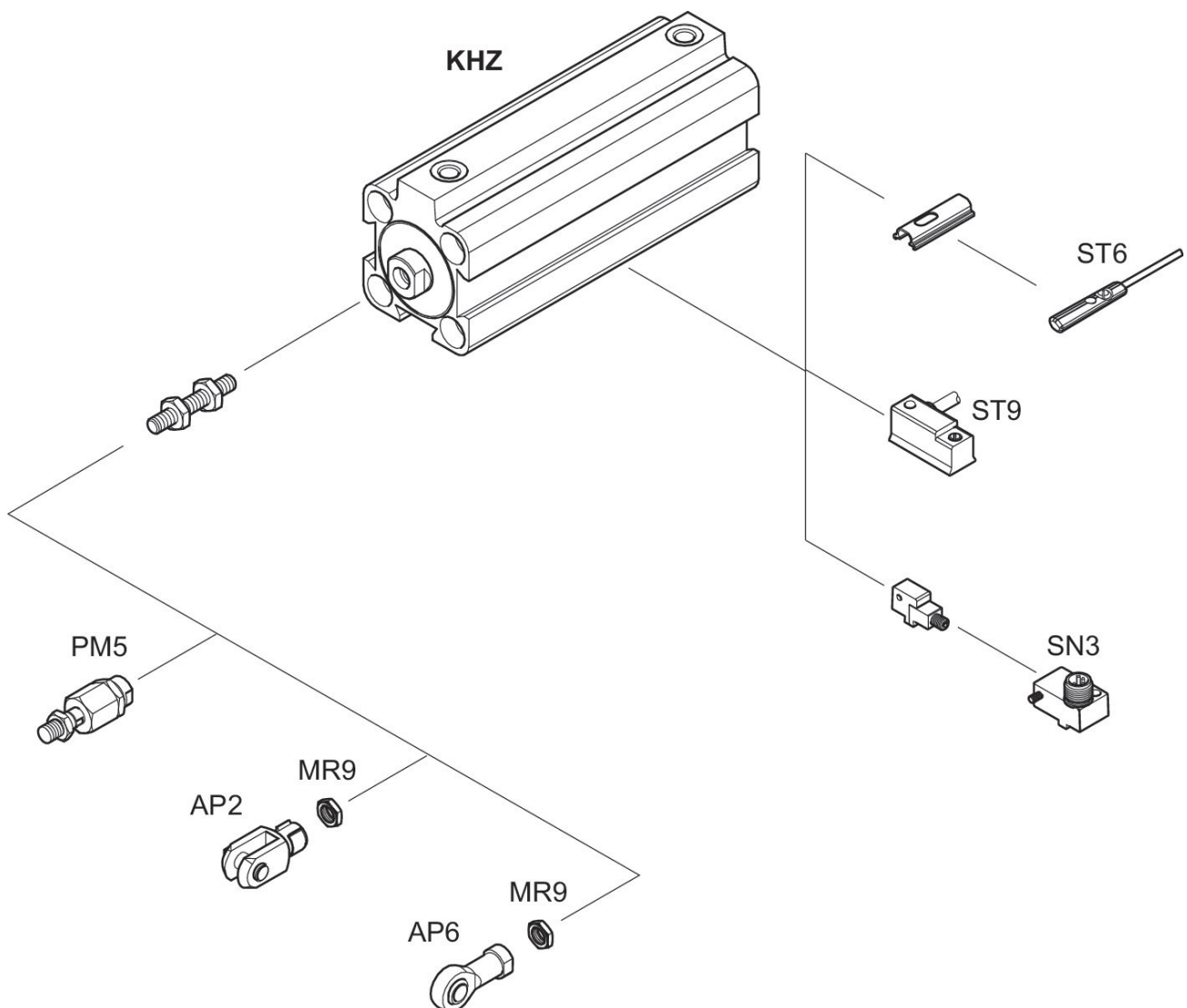

NOTE: This overview drawing is only for orientation to indicate where the various accessory parts can be fastened to the cylinder. The illustration has been simplified for this purpose. It is thus not possible to derive the dimensions from this overview.