

Foot mounting, Series M41, M48

R402003402

Foot
mountings

2024-08-29

AVENTICS Foot mountings

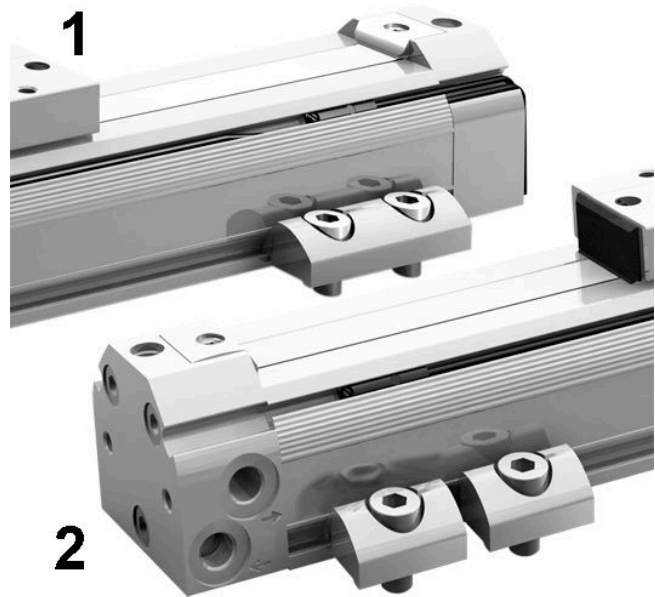

Technical data

Industry	Industrial
For series	RTC
Piston diameter	32 mm 40 mm
Delivery unit	2 piece
Weight	0.07 kg

Material

Material	Aluminum
Fig.	Fig. 1
Part No.	R402003402

Number

Foot mounting, Series M41, M48

R402003402

Foot
mountings

2024-08-29

Foot mounting



Piston Ø	2 sets up to a stroke length of	3 sets up to a stroke length of	1 additional set per stroke length of
16	1200	1600	800
25	1400	1800	900
32	1500	2000	1000
40	1600	2100	1050
50	1700	2200	1100
63	1900	2400	1200

Dimensions

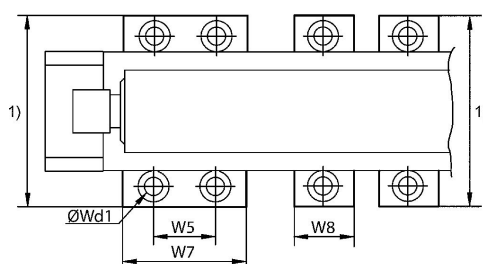

1) see data sheet for the respective product variant

Series	Part No.	Piston Ø	For series	Wd1	W5	W7	W8	Fig.
M41	R402003401	16, 25	RTC-BV, RTC-CG, RTC-HD, RTC-SB	6,8	30	60	–	Fig. 1
M41	R402003402	32, 40	RTC-BV, RTC-CG,	8,8	30	60	–	Fig. 1

Foot mounting, Series M41, M48

R402003402

Foot
mountings

2024-08-29

Series	Part No.	Piston Ø	For series	Wd1	W5	W7	W8	Fig.
M41	R402003403	50, 63, 80	RTC-HD, RTC-SB	13	40	80	–	Fig. 1
M48	R402003404	16, 25	RTC-BV, RTC-CG, RTC-HD, RTC-SB	6,8	–	–	30	Fig. 2
M48	R402003405	32, 40	RTC-BV, RTC-CG, RTC-HD, RTC-SB	8,8	–	–	30	Fig. 2
M48	R402005912	50, 63, 80	RTC-BV, RTC-CG, RTC-HD, RTC-SB	13	–	–	40	Fig. 2