

## AVENTICS Series KPZ Compact cylinders

The AVENTICS Series KPZ is a compact cylinders based on the widely used standard NFE 49 004. It offer a wide variety of variants and are suitable for a multitude of applications thanks to their sizing.

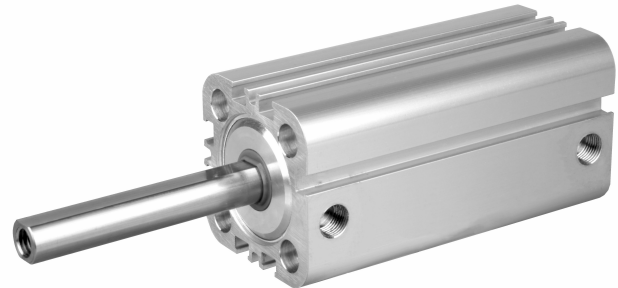

### Technical data

Industry	Industrial
Standards	NFE 49004
Piston Ø	63 mm
Stroke	20 mm
Ports	G 1/8
Functional principle	Double-acting
Cushioning	Elastic cushioning
Magnetic piston	Piston with magnet
Environmental requirements	Industry standard ATEX optional
Piston rod thread - type	Internal thread
Piston rod thread	M10
Piston rod	Non-rotating, biplane
Scraper	Standard Industry Scraper
Pressure for determining piston forces	6,3 bar
Retracting piston force	1827 N
Extracting piston force	1964 N
Min. ambient temperature	-20 °C
Max. ambient temperature	80 °C
Min. working pressure	0.6 bar

# Compact cylinder, Series KPZ

0822396903

Series KPZ

2024-04-09

---

Max. working pressure	10 bar
Impact energy	1.3 J
Max. torque for torsion protection	1.5 Nm
Stroke max.	300 mm
Medium	Compressed air
Min. medium temperature	-20 °C
Max. medium temperature	80 °C
Max. particle size	50 µm
Min. oil content of compressed air	0 mg/m <sup>3</sup>
Max. oil content of compressed air	5 mg/m <sup>3</sup>

## Material

Piston rod	Stainless Steel
Scraper material	Polyurethane
Seal material	Polyurethane
Material, front cover	Aluminum
Cylinder tube	Aluminum
End cover	Aluminum
Part No.	0822396903

## Technical information

Use our Internet configurator to order variants with an external thread.

The pressure dew point must be at least 15 °C less than ambient and medium temperature and may not exceed 3 °C.

The oil content of compressed air must remain constant during the life cycle.

Use only the approved oils from AVENTICS. Further information can be found in the "Technical information" document (available in <https://www.emerson.com/en-us/support>).

# Compact cylinder, Series KPZ

0822396903

Series KPZ

2024-04-09

## Dimensions

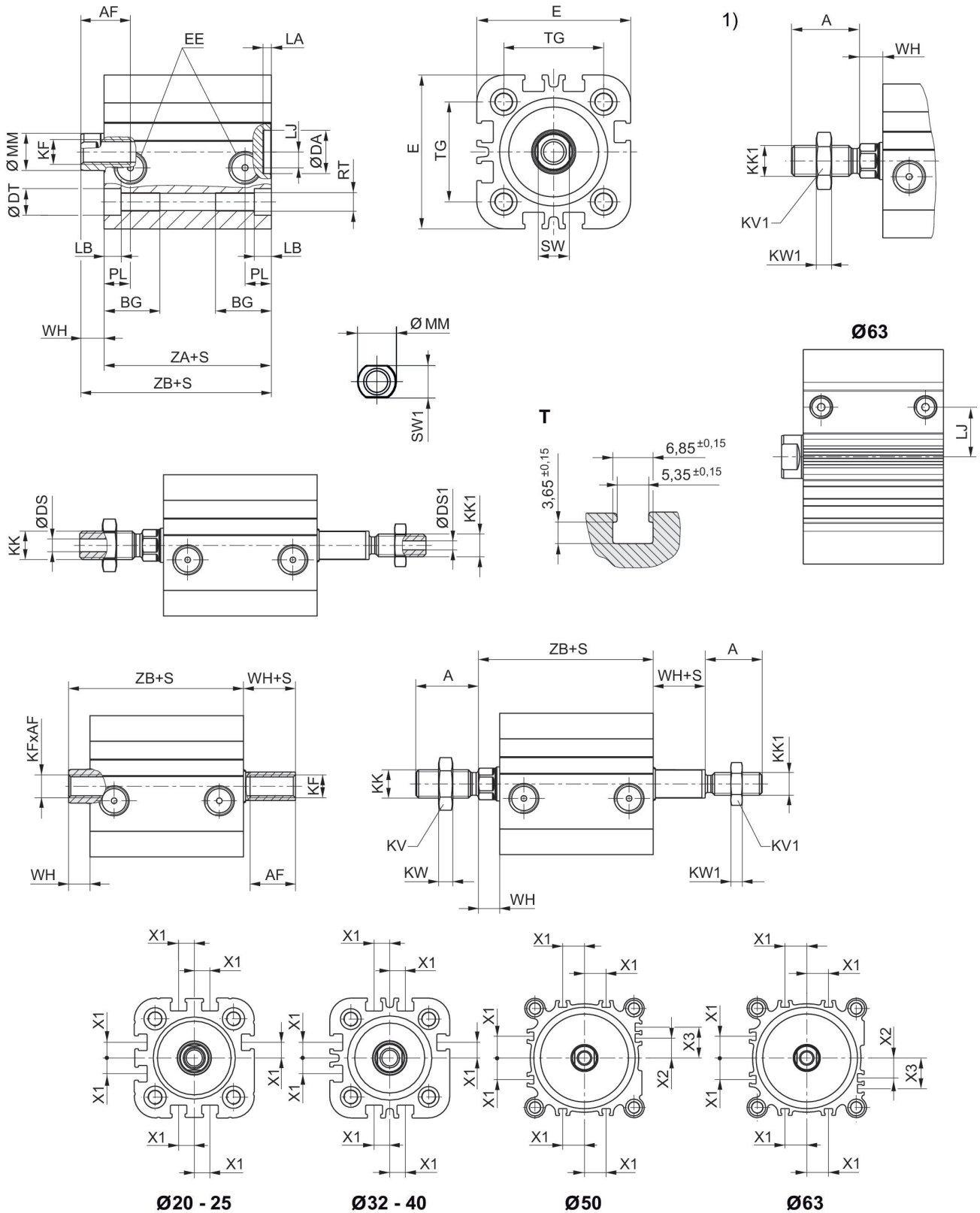

S = stroke

T = View for sensor groove

1) External thread

Use our Internet configurator to order variants with an external thread.

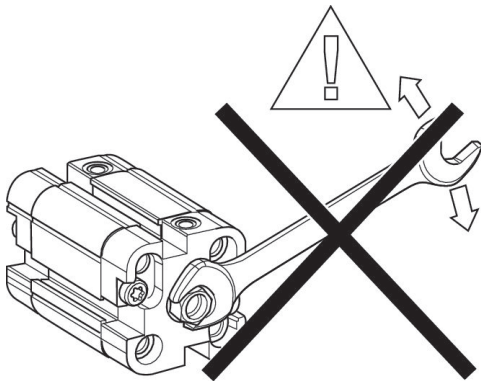

## Maximum admissible lateral force dynamic

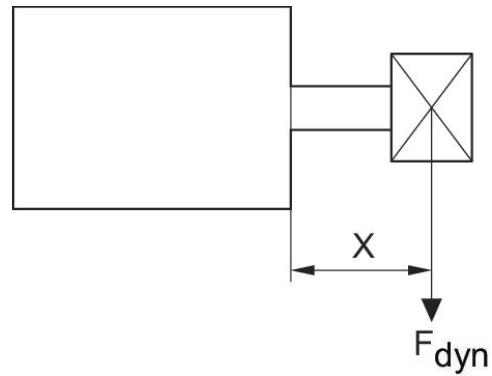

$F_{dyn}$  = dynamic lateral force  
 $X$  = distance between force application point and cylinder cover  
 $S$  = stroke

## Maximum admissible lateral force dynamic

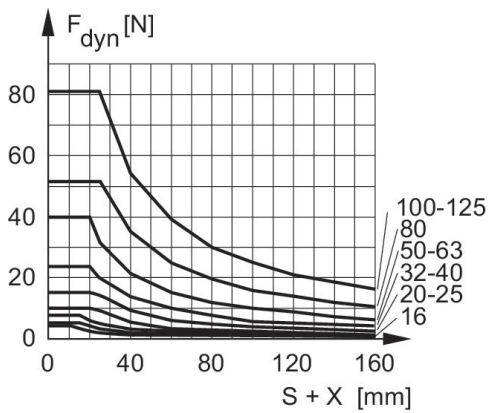

$F_{dyn}$  = dynamic lateral force  
 $X$  = distance between force application point and cylinder cover  
 $S$  = stroke

## Maximum admissible lateral force static

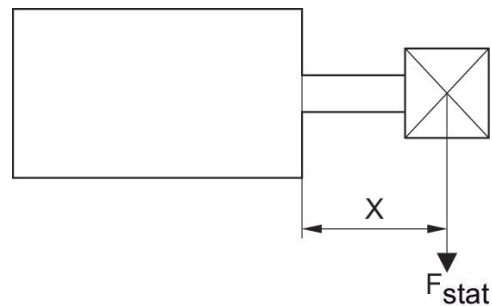

$F_{stat}$  = static lateral force  
 $X$  = distance between force application point and cylinder cover

## Maximum admissible lateral force static

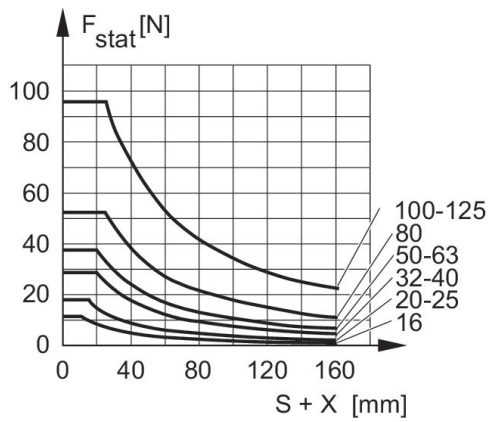

F stat. = static lateral force  
 X = distance between force application point and cylinder cover  
 S = stroke

## Overview drawing

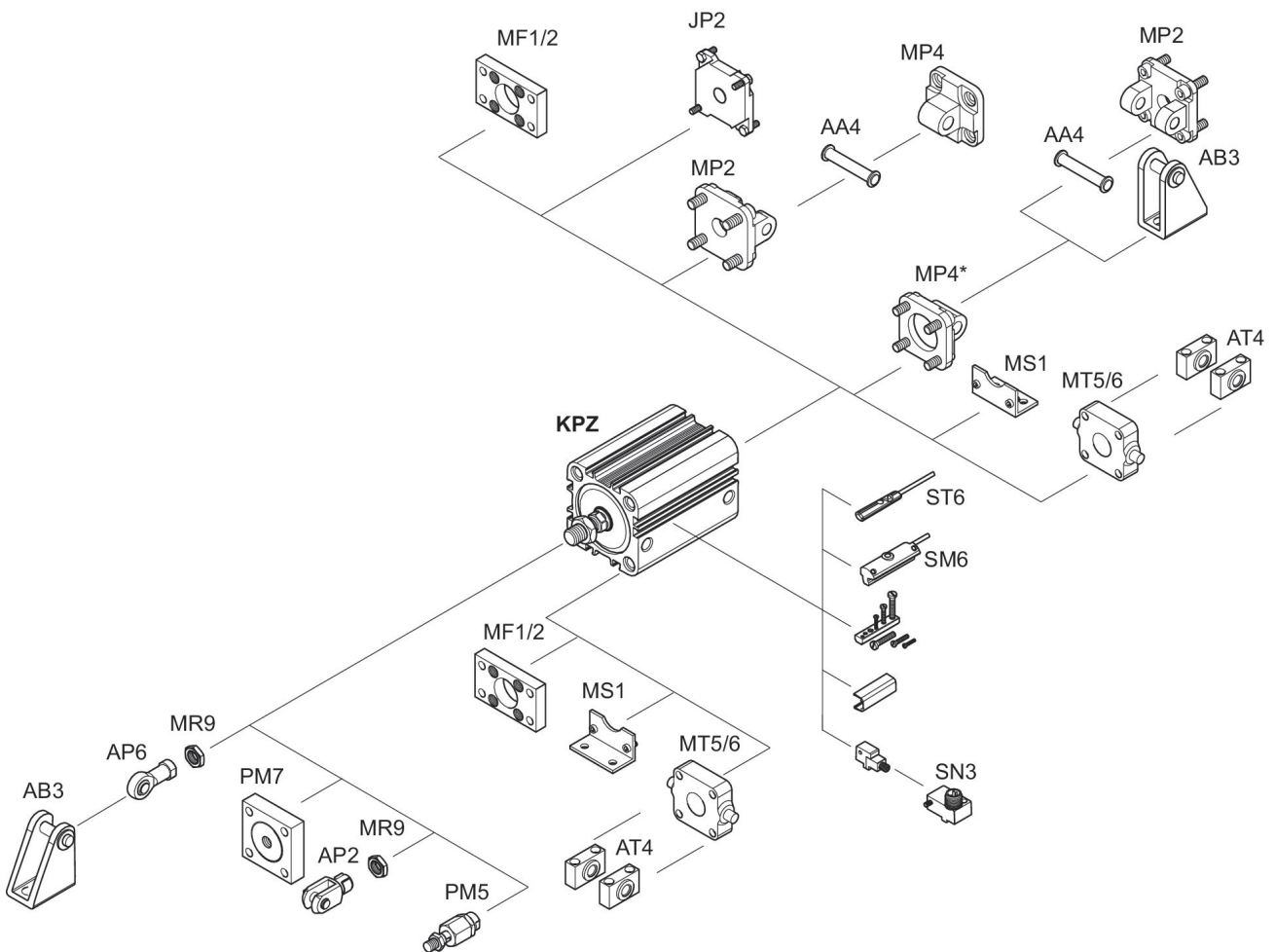

\* Available for installation on KPZ for cylinder diameters 16 - 25 mm

# Compact cylinder, Series KPZ

0822396903

Series KPZ

2024-04-09

NOTE: This overview drawing is only for orientation to indicate where the various accessory parts can be fastened to the cylinder. The illustration has been simplified for this purpose. It is thus not possible to derive the dimensions from this overview.

Piston Ø	A	AF min. Option: through piston rod	BG min.	Ø DA H11	Ø DS	Ø DS1	Ø DT H13	E	EE
20	22	12 10: S<3 mm 2)	15,5	12	3	-	7,5	36	M5
25	22	12 10: S<3 mm 2)	15,5	12	3	-	8	40	M5
32	22	12	18	14	4,5	3	8,6	50	G 1/8
40	22	12	18	14	4,5	3	9	58	G 1/8
50	24	16 12: S<4 mm 2)	24	18	6	6	11	68	G 1/8
63	24	16 12: S<4 mm 2)	24	18	6	6	11	80	G 1/8

Piston Ø	KF	KK	KK1	KV	KV1	KW	KW1	LA	LB
20	M6	M10x1,25	M8x1,25	16	13	5	4	2,5	4,5
25	M6	M10x1,25	M8x1,25	16	13	5	4	2,5	4,4
32	M8	M10x1,25	M8x1,25	16	13	5	4	2,5	5,5
40	M8	M10x1,25	M8x1,25	16	13	5	4	2,5	5,5
50	M10	M12x1,25	M10x1,25	18	16	6	5	2,5	2
63	M10	M12x1,25	M10x1,25	18	16	6	5	2,5	2

Piston Ø	LJ	LW	MM f8	PL	RT	SW	SW1	TG	WH
20	4,5	3,7	10	7,5	M5	8	8	22 ±0,4	5
25	5	3,7	10	7,5	M5	8	8	26 ±0,4	5,5
32	5,1	5	12	8,5	M6	10	10	32 ±0,5	7
40	9,6	5	12	8,5	M6	10	10	42 ±0,5	7
50	8,5	5,7	16	8,5	M8	13	13	50 ±0,6	7,5
63	17,8	5,7	16	8,5	M8	13	13	62 ±0,7	8

Piston Ø	X1	X2	X3	ZA + Stroke	ZB + Stroke
20	4,2	-	-	38	43 0/+1,4
25	4,5	-	-	39	44,5 0/+1,6
32	6,5	-	-	44	51 0/+1,6
40	11	-	-	45	52 0/+1,6
50	13	4	13	45,5	53 0/+1,6
63	18	12	21	49	57 ±2