

AVENTICS Series KPZ Compact cylinders

The AVENTICS Series KPZ is a compact cylinders based on the widely used standard NFE 49 004. It offer a wide variety of variants and are suitable for a multitude of applications thanks to their sizing.

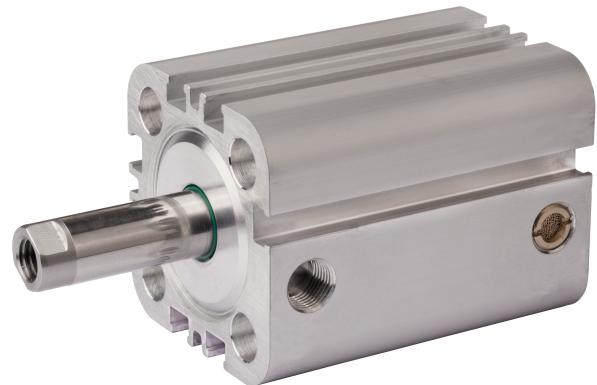

Technical data

Industry	Industrial
Standards	NFE 49004
Piston Ø	25 mm
Stroke	5 mm
Ports	M5
Functional principle	Single-acting, extended without pressure
Cushioning	Elastic cushioning
Magnetic piston	Piston with magnet
Environmental requirements	Industry standard
Piston rod thread - type	Internal thread
Piston rod thread	M6
Piston rod	single
Scraper	Standard Industry Scraper
Pressure for determining piston forces	6,3 bar
Retracting piston force	309 N
Extracting piston force	25 N
Min. ambient temperature	-20 °C
Max. ambient temperature	80 °C
Min. working pressure	1.5 bar

Compact cylinder, Series KPZ

0822492100

Series KPZ

2024-04-09

Max. working pressure	10 bar
Impact energy	0.2 J
Weight 0 mm stroke	0.143 kg
Weight +10 mm stroke	0.02 kg
Stroke max.	25 mm
Medium	Compressed air
Min. medium temperature	-20 °C
Max. medium temperature	80 °C
Max. particle size	5 µm
Min. oil content of compressed air	0 mg/m ³
Max. oil content of compressed air	5 mg/m ³

Material

Piston rod	Stainless Steel
Scraper material	Polyurethane
Seal material	Nitrile butadiene rubber
Material, front cover	Aluminum
Cylinder tube	Aluminum
End cover	Aluminum
Part No.	0822492100

Technical information

The material for heat-resistant scraper and seal variants (ambient temperature: -10 °C ... 120 °C) is fluorocarbon.

Further options can be generated in the Internet configurator.

The pressure dew point must be at least 15 °C less than ambient and medium temperature and may not exceed 3 °C.

The oil content of compressed air must remain constant during the life cycle.

Use only the approved oils from AVENTICS. Further information can be found in the "Technical information" document (available in <https://www.emerson.com/en-us/support>).

Compact cylinder, Series KPZ

0822492100

Series KPZ

2024-04-09

Dimensions

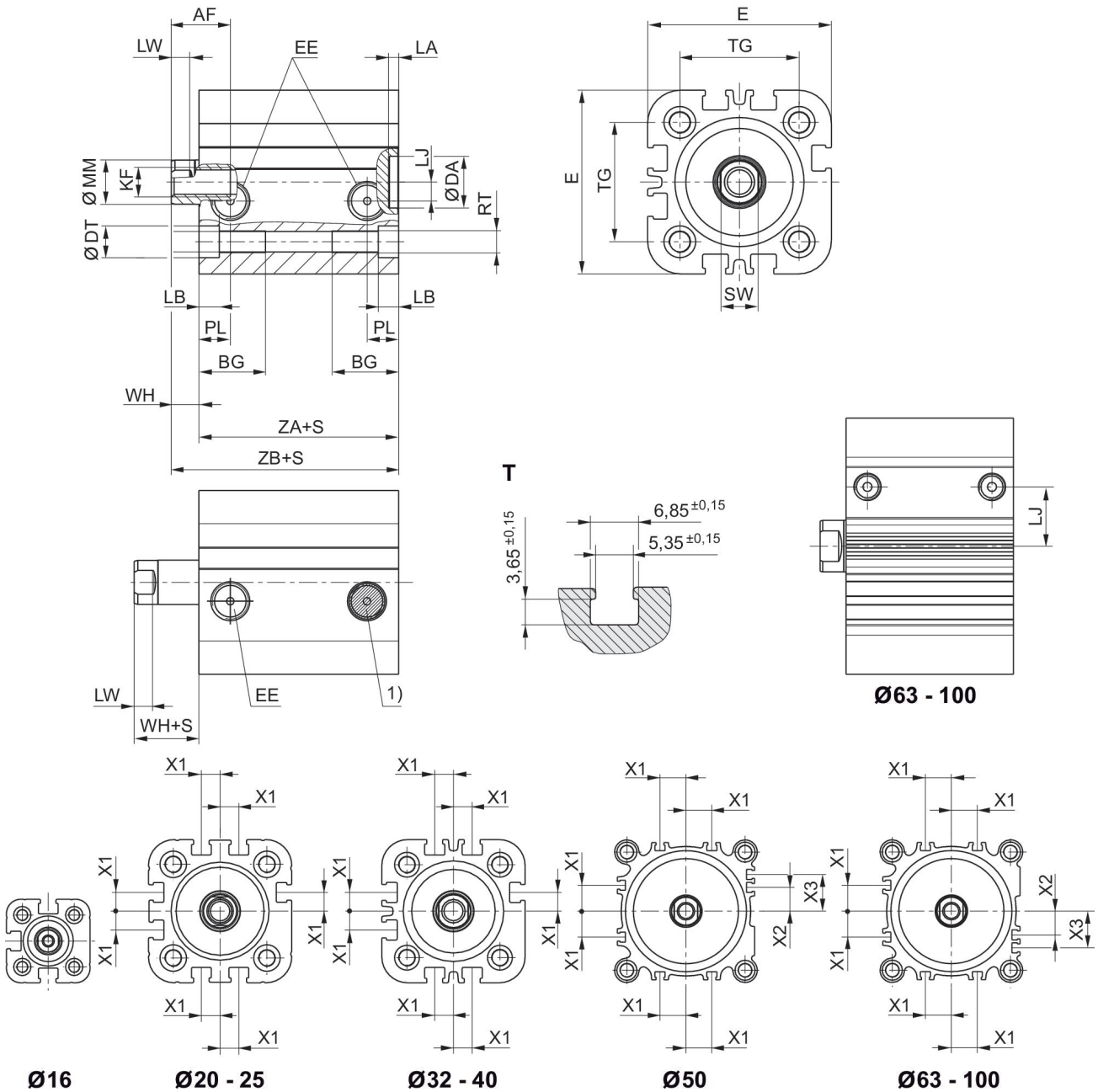

S = stroke
T = View for sensor groove

Piston Ø	AF	BG min.	DA H11	DT H13	E	EE	KF	LA	LB
16	10	14.5	10	6	29.5	M5	M4	2.5	3.5
20	12	15.5	12	7.5	36	M5	M6	2.5	4.5
25	12	15.5	12	8	40	M5	M6	2.5	4.4
32	12	18	14	8.6	50	G 1/8	M8	2.5	5.5
40	12	18	14	9	58	G 1/8	M8	2.5	5.5

Compact cylinder, Series KPZ

0822492100

Series KPZ

2024-04-09

Piston Ø	AF	BG min.	DA H11	DT H13	E	EE	KF	LA	LB
50	16	24	18	11	68	G 1/8	M10	2.5	2
63	16	24	18	11	80	G 1/8	M10	2.5	2
80	20	28	23	14	99	G 1/8	M12	3	1
100	26	27.5	28	15	120	G 1/8	M16	3	3.5

Piston Ø	LJ	LW	MM f8	PL	RT	SW	TG	WH	X1
16	2.5	2.8	8	7.5	M4	7	18 ±0,4	4.5	–
20	4.5	3.7	10	7.5	M5	8	22 ±0,4	5	4.2
25	5	3.7	10	7.5	M5	8	26 ±0,4	5.5	4.5
32	5.1	5	12	8.5	M6	10	32 ±0,5	7	6.5
40	9.6	5	12	8.5	M6	10	42 ±0,5	7	11
50	8.5	5.7	16	8.5	M8	13	50 ±0,6	7.5	13
63	17.8	5.7	16	8.5	M8	13	62 ±0,7	8	18
80	22.9	7	20	8.3	M10	16	82 ±0,7	9.5	18
100	26.5	7.5	25	9.7	M10	21	103 ±0,7	10.5	20

Piston Ø	X2	X3	ZA + Stroke	ZB + Stroke
16	–	–	38	42,5 0/+1,2
20	–	–	38	43 0/+1,4
25	–	–	38	44,5 0/+1,4
32	–	–	44	51 0/+1,6
40	–	–	45	52 0/+1,6
50	4	13	45.5	53 0/+1,6
63	12	21	49	57 0/+2
80	16.5	25.5	54.5	64 0/+2
100	20	29	66.5	77 0/+2

Extracting piston force

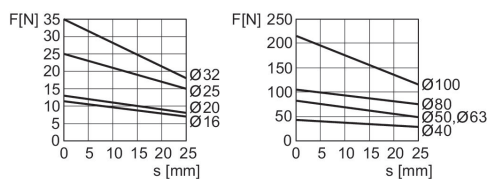

F = spring return force, s = return stroke

Overview drawing



* Available for installation on KPZ for cylinder diameters 16 - 25 mm

NOTE: This overview drawing is only for orientation to indicate where the various accessory parts can be fastened to the cylinder. The illustration has been simplified for this purpose. It is thus not possible to derive the dimensions from this overview.