

3/2 directional valve, LS04-AF series

R422103585

2024-12-13

AVENTICS Series LS04 Directional valves

The AVENTICS Series LS04 are lightweight spool valves and save space with their polyamide and aluminium housing. The valves are suitable for direct mounting onto moving machines and system parts.

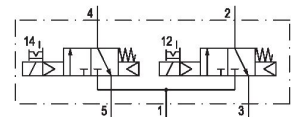
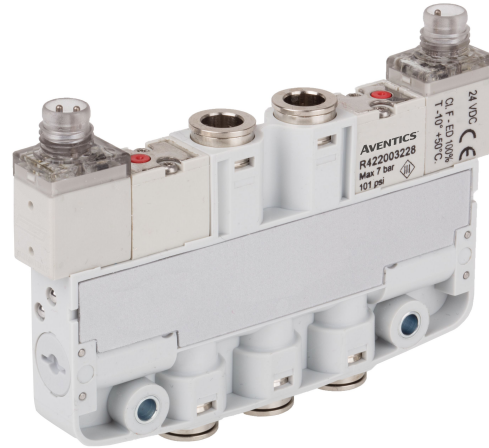

Technical data

Industry	Industrial
Activation	Electrically
Valve type	Spool valve, positive overlapping
Switching principle	2x 3/2 NC/NC, with spring return
Valve function	NC/NC
Sealing principle	Soft seal
Connection type	Pipe connection
Manual override	with detent
Compressed air connection input	Ø 4
Compressed air connection output	Ø 4
Compressed air connection, exhaust	Ø 4
Nominal flow Qn	180 l/min
Flow conductance b	0.4
Flow conductance C	0.8 l/(s*bar)
Min. working pressure	3 bar
Max. working pressure	7 bar

3/2 directional valve, LS04-AF series

R422103585

2024-12-13

Electrical connection type	Plug
Electrical connection size	M8
Electrical connection number of poles	3-pin
Connector standard	DIN EN 60947-5-2
Protection class acc. to DIN EN 61140	Class III
Protection class with connection	IP65
Protective circuit	Z-diode
Operational voltage	24 V DC
Operational voltage DC	24 V
Voltage tolerance DC	-10 % / +10 %
Pilot	Internal
LED status display	Yellow
Power consumption DC	0.8 W
Duty cycle	100 %
Typ. switch-on time	12 ms
Typ. switch-off time	15 ms
Generic emission standard in accordance with	EN 61000-6-4:2002
Generic immunity standard in accordance with	IEC 61000-6-2:2005
Min. ambient temperature	-10 °C
Max. ambient temperature	50 °C
Min. medium temperature	-10 °C
Max. medium temperature	50 °C
Medium	Compressed air
Min. oil content of compressed air	0 mg/m ³
Max. oil content of compressed air	5 mg/m ³
Max. particle size	5 µm
Mounting screws	M3
Mounting screw tightening torque	0.5 Nm
Weight	0.064 kg
Material	
Housing material	Polyoxymethylene
Seal material	Acrylonitrile butadiene rubber Hydrogenated nitrile butadiene rubber

3/2 directional valve, LS04-AF series

R422103585

2024-12-13

Polyurethane

Part No.

R422103585

Technical information

The min. control pressure must be adhered to, since otherwise faulty switching and valve failure may result!

The pressure dew point must be at least 15 °C less than ambient and medium temperature and may not exceed 3 °C.

The oil content of compressed air must remain constant during the life cycle.

Use only the approved oils from AVENTICS. Further information can be found in the "Technical information" document (available in <https://www.emerson.com/en-us/support>).

A duty cycle of 100 percent is only valid for single valves.

Dimensions

3/2 directional valve, LS04-AF series

R422103585

2024-12-13

Double Solenoid

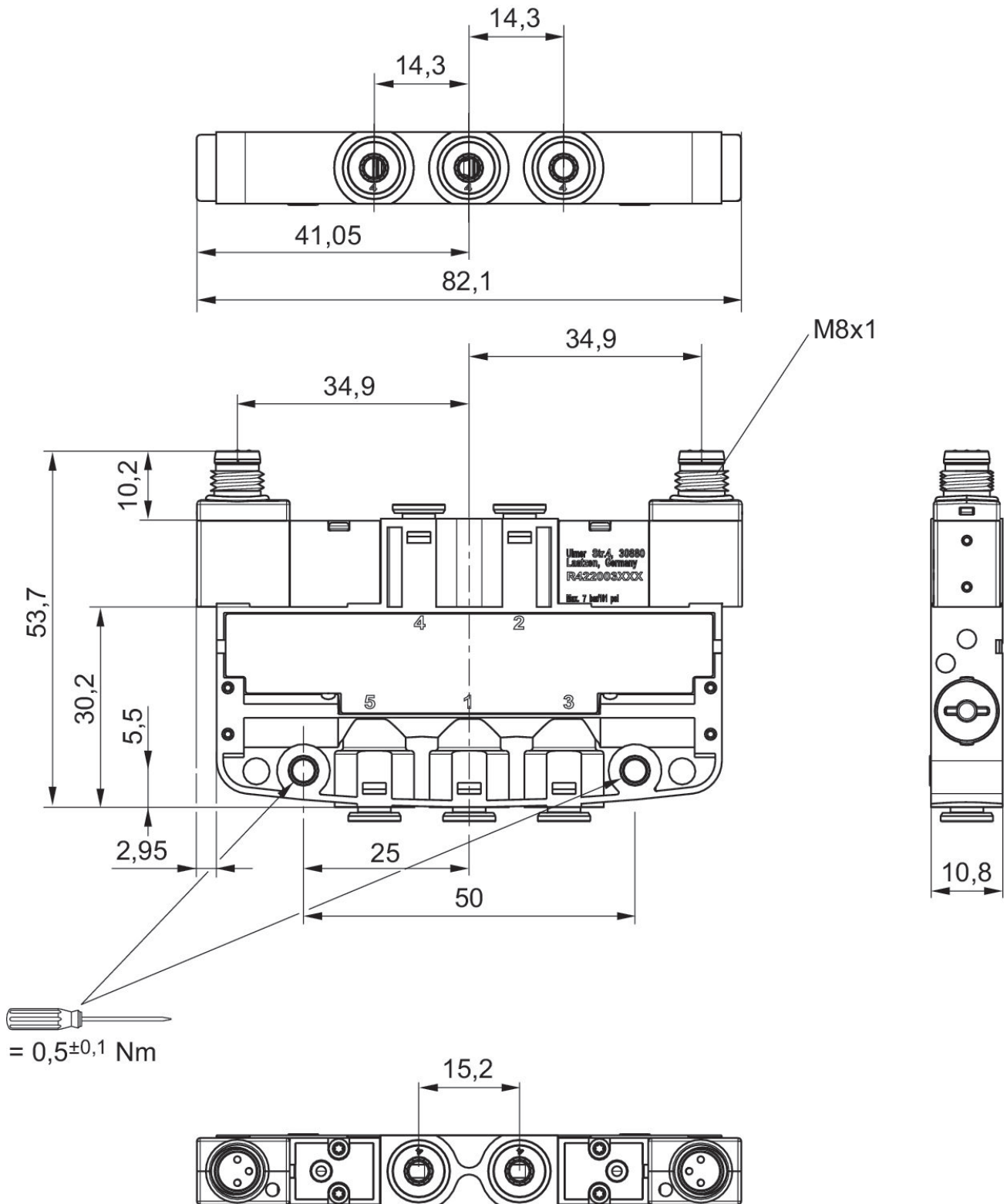

3/2 directional valve, LS04-AF series

R422103585

2024-12-13

PIN assignment for valve plug
connectors

3-pin

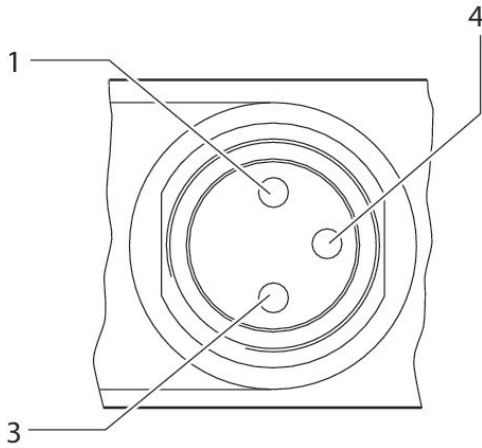

1) Pin not assigned 3) 0 V 4) 24 V Note: Bi-polar protective circuit to prevent overvoltage