

Locking unit, Series LU1

0821401137

General series information
AVENTICS Series LU1 Locking units

- The AVENTICS Series LU1 is a an holding unit using eccentric movement to hold the piston rod in any position.

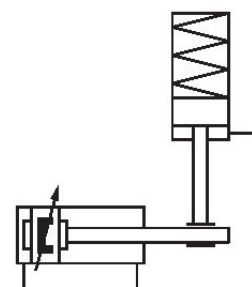

Technical data

Industry

Function

Function

Piston Ø

suitable piston rod Ø

Piston rod extension

Compressed air connection

Release pressure min.

Release pressure max.

Min. medium temperature

Max. medium temperature

Industrial

Clamp with eccentric tappet

hold: spring force, release: compressed air

80 mm

100 mm

25 mm

140 mm

G 1/8

5.5 bar

8 bar

-20 °C

80 °C

Medium	Compressed air
Max. particle size	5 µm
Min. ambient temperature	-20 °C
Max. ambient temperature	80 °C
Oil content of compressed air min.	0 mg/m ³
Oil content of compressed air max.	5 mg/m ³
Static holding force	5800 N
Weight	7.7 kg

Material

Housing	Aluminum
Surface housing	anodized
Cover	Die-cast aluminum
Part No.	0821401137

Technical information

Warning: The Locking unit may not be used for the following applications: - for dynamic holding - in or as safety equipment

Locking unit may only be unlocked when turned off.

Dimensions

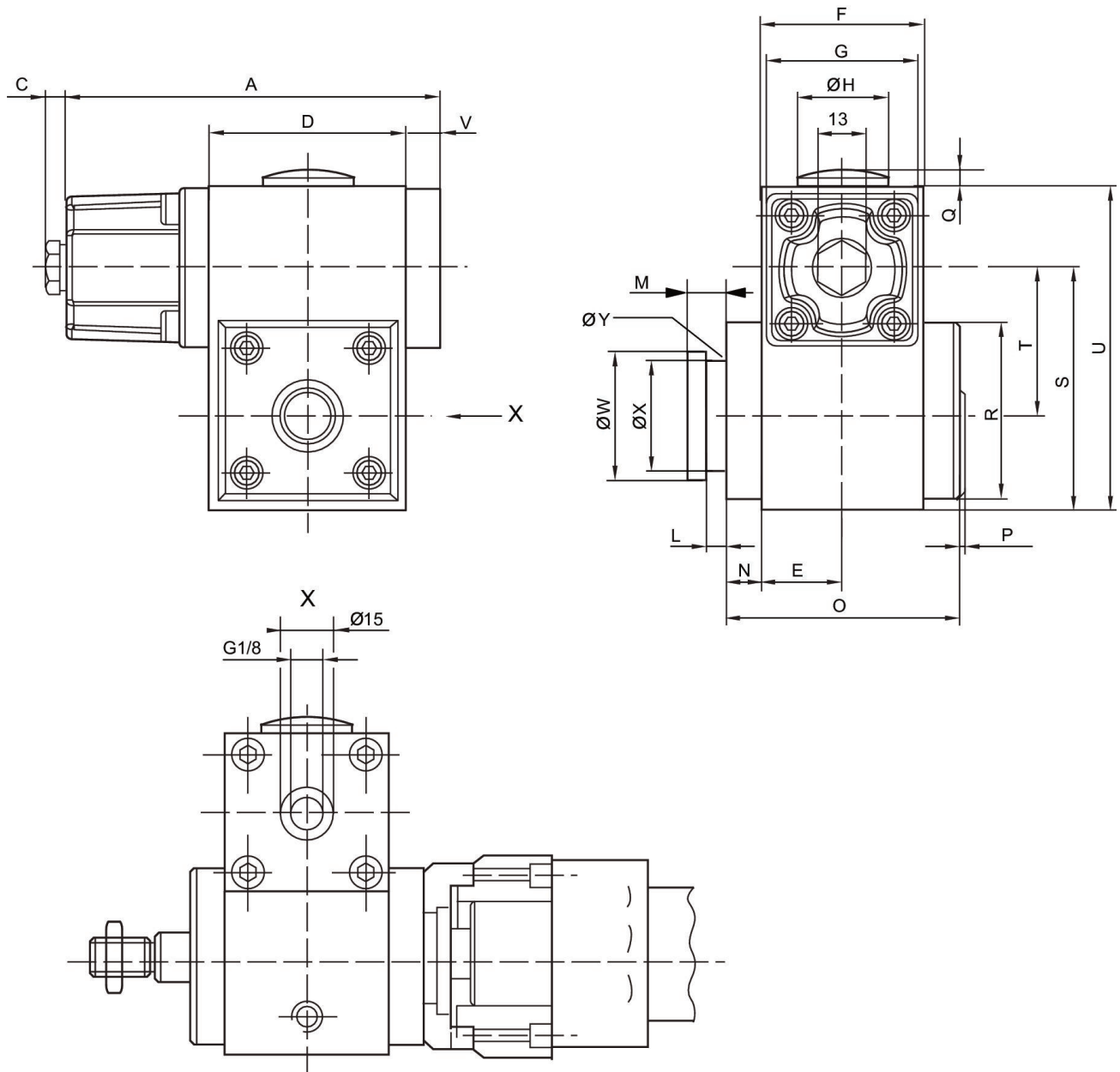

Piston Ø	Part No.	A	C	D	E	F	G	Ø H	L
32	R412003730	106	6	56	23	46	45	30	4.1
32	0821401134	106	6	56	23	46	45	30	4.1
40	R412003731	106	6	56	23	46	45	30	5.1
40	0821401135	106	6	56	23	46	45	30	5.1
50, 63	R412003732	139.5	6	69	30	60	55	30	5.1
50, 63	0821401136	139.5	6	69	30	60	55	30	5.1
80, 100	R412003733	176.5	6	100	40	80	65	37.5	8.1
80, 100	0821401137	176.5	6	100	40	80	65	37.5	8.1

Piston Ø	M	N	O	P	Q	R	S	T	U
32	8	9	65	3	2.5	50	68.5	41.9	91.5
32	8	9	65	3	2.5	50	68.5	41.9	91.5
40	10	9	65	3	2.5	50	68.5	40.5	91.5
40	10	9	65	3	2.5	50	68.5	40.5	91.5
50, 63	10	9	83.5	3	2.5	60	79.5	48	110
50, 63	10	9	83.5	3	2.5	60	79.5	48	110
80, 100	16	13	118	3	2	90	119	72	155
80, 100	16	13	118	3	2	90	119	72	155

Piston Ø	V	Ø W	Ø X	Ø Y
32	10	29.9	24	3
32	10	29.9	24	3
40	10	39.9	30	3
40	10	39.9	30	3
50, 63	10	39.9	30	3
50, 63	10	39.9	30	3
80, 100	10	54.9	40	5
80, 100	10	54.9	40	5