

Standard oil-mist lubricator, Series 652

G652AL0L30A0000

General series information Series 652

- The AVENTICS Series 652 is an easy-to-install line of pneumatic filters, regulators and lubricators (FRLs) that offer the industry's highest flow rates and widest temperature ratings. Available in 1/4-inch, 3/8-inch, and 1/2-inch port sizes, these FRLs are ideal for automotive and tire, packaging, food and beverage, and process applications requiring highly reliable operation and robust, modern-looking equipment. Available with integrated redundant safe exhaust valve and IIoT enabled air flow sensor.



Technical data

Industry	Industrial
Parts	Lubricator
Reservoir	reservoir, metal, with inspection glass
Compressed air connection	G 3/8
Nominal flow Qn	5000 l/min
Working pressure min.	0 bar
Working pressure max	10 bar
Min. ambient temperature	5 °C
Max. ambient temperature	50 °C
Medium	Compressed air Neutral gases
Certificates	ATEX optional
ATEX	ATEX optional
Lubricator reservoir volume	72 cm ³

Function	Oil-mist lubricator
Function	Can be assembled into blocks
Weight	0.67 kg

Material

Housing material	Aluminum
Material front plate	Polycarbonate
Seal material	Nitrile butadiene rubber
Material reservoir	Aluminum
Part No.	G652AL0L30A0000

Technical information

Recommended oil type
Non-detergent type and without aggressive additives (VG32-ISO3448)

Dimensions

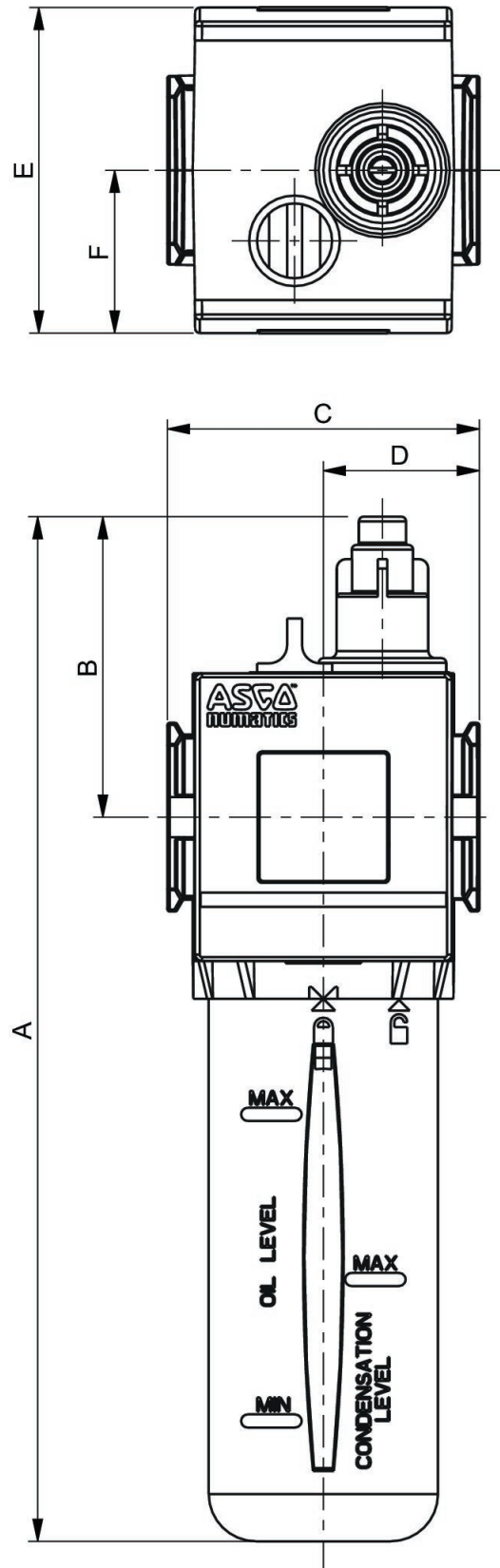

To remove the reservoir, allow a clearance of [[25] mm] from the bottom of the reservoir drain.

Series	652
A	217
B	64
C	66
D	33
E	69
F	30,5

Accessories overview

