

Pressure regulators, Series M Plus™

R431000662

Pressure regulators, Series M Plus™

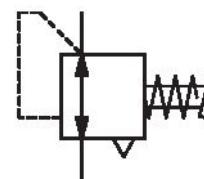

Technical data

Industry
Industrial

Type
Poppet valve

Compressed air connection input
1/8-27 NPTF

Compressed air connection output
1/8-27 NPTF

Working pressure min.
0 bar

Working pressure max
10.3 bar

Regulation range min.
0 bar

Regulation range max.
4.1 bar

Min. ambient temperature
-40 °C

Max. ambient temperature
71 °C

Min. medium temperature
-40 °C

Max. medium temperature
71 °C

Medium
Compressed air

Max. particle size
50 µm

Oil content of compressed air min.
0 mg/m³

Oil content of compressed air max.
1 mg/m³

Nominal flow Qn
200 l/min

Weight
0.75 kg

Part No.
R431000662

Technical information

The min. control pressure must be adhered to, since otherwise faulty switching and valve failure may result!

The pressure dew point must be at least 15 °C under ambient and medium temperature and may not exceed 3 °C .

The oil content of compressed air must remain constant during the life cycle.

Use only the approved oils from AVENTICS. Further information can be found in the “Technical information” document (available in <https://www.emerson.com/en-us/support>).

Dimensions in inches

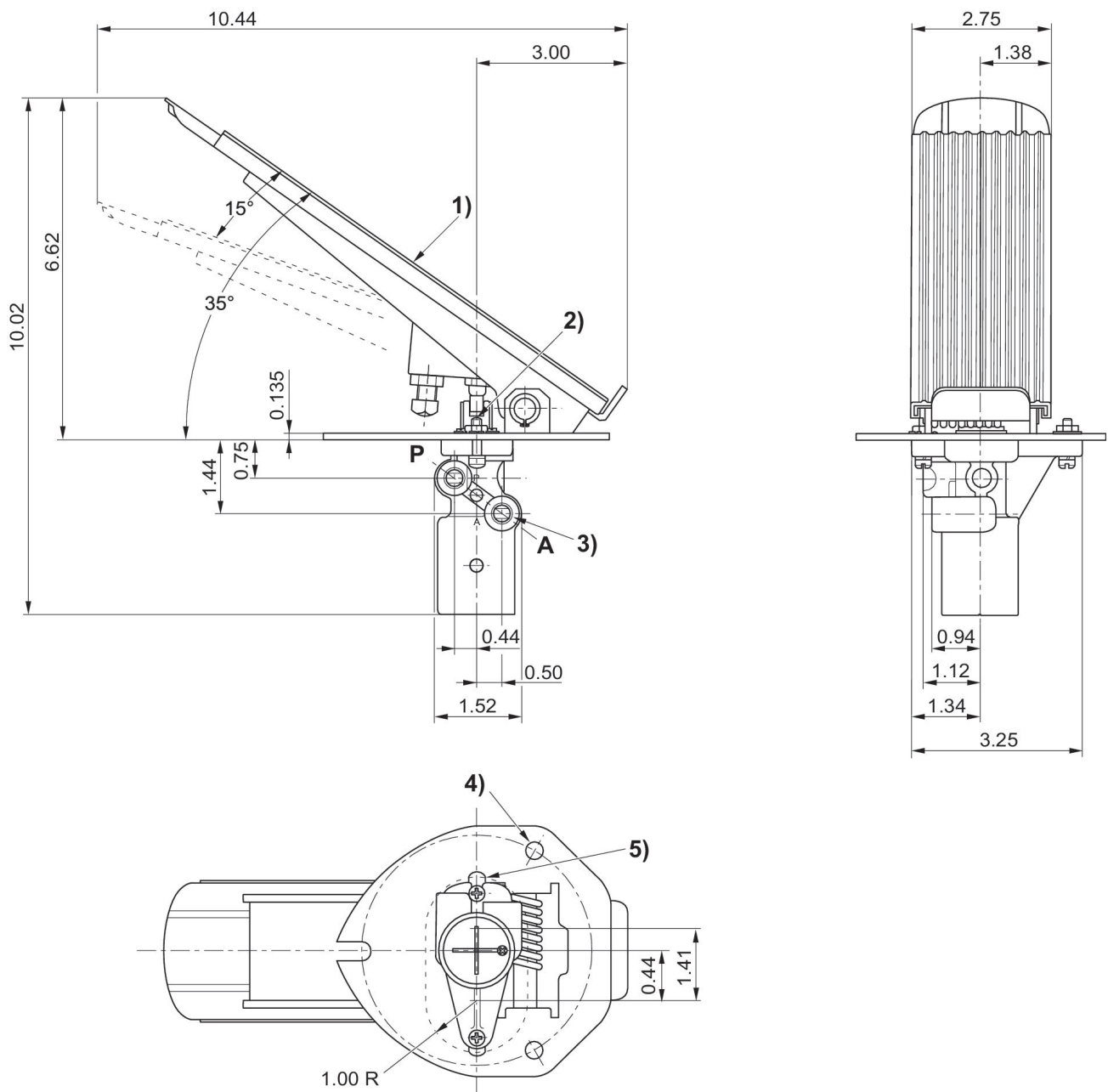

- 1) Pedal
- 2) Exhaust
- 3) 1/8-27 NPTF
- 4) 0.34 diameter through 3 places equally spaced on a 4.50 diameter between centers.
- 5) panel mounting hole