

Silencers, series S11

1827000032

General series information
AVENTICS Series S11 Silencers

- AVENTICS Series S11 Silencers offers a broad range of silencers even in Metal or plastic to reduce the noise when Pneumatic products come to exhaust.

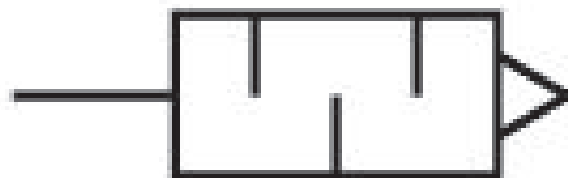

Technical data

Industry	Industrial
Medium	Compressed air
Working pressure min.	0 bar
Working pressure max	10 bar
Min. ambient temperature	-25 °C
Max. ambient temperature	80 °C
Compressed air connection	M5
Compressed air connection type	External thread
Sound pressure level	79 dB
Nominal flow Qn	252 l/min
Delivery unit	10 piece
Weight	0.005 kg

Material

Silencer material

Sintered bronze

Material thread

Brass

Part No.

1827000032

Dimensions

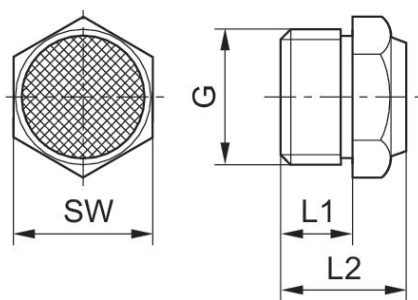

Part No.	Port G	L1	L2	SW
1827000032	M5	5	10.3	7
1827000031	G 1/8	6	11.5	13
1827000033	G 1/4	8	13.5	17
1827000034	G 3/8	10	17.5	22
1827000035	G 1/2	12	19.5	27
8145003400	G 3/4	14	22.5	32
8145001000	G 1	16	22.5	41

Sound pressure level measured at 6 bar at 1 m distance

Flow diagram

8145001000

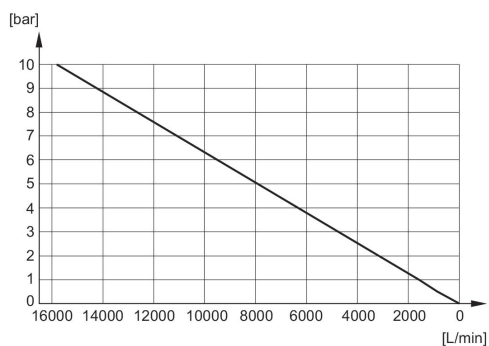

Flow diagram

8145003400

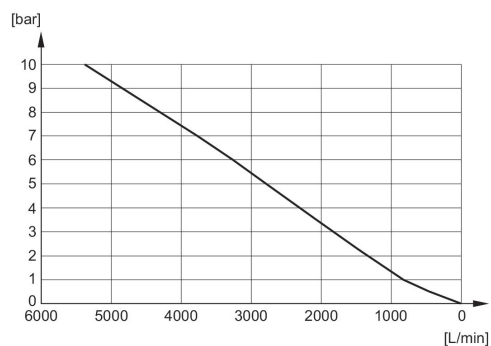

Flow diagram
1827000035

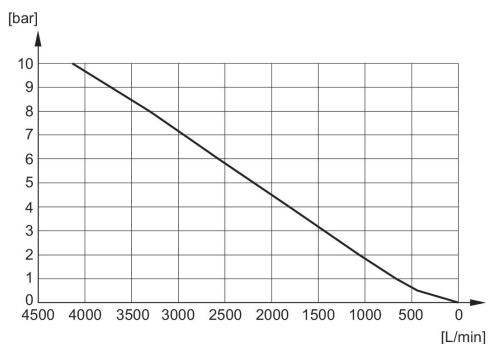

Flow diagram
1827000034

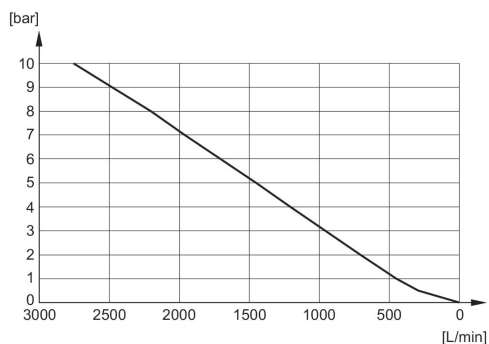

Flow diagram
1827000033

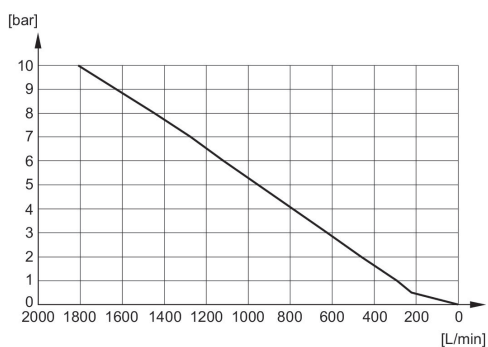

Flow diagram
1827000031

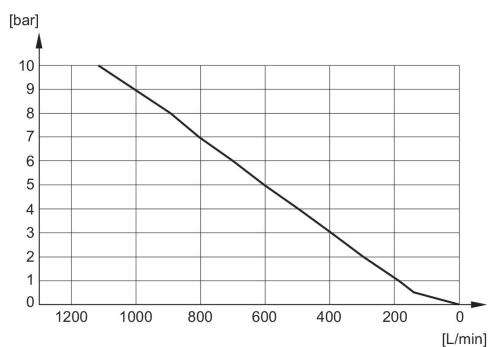

Flow diagram
1827000032

