

## AVENTICS Rear eyes

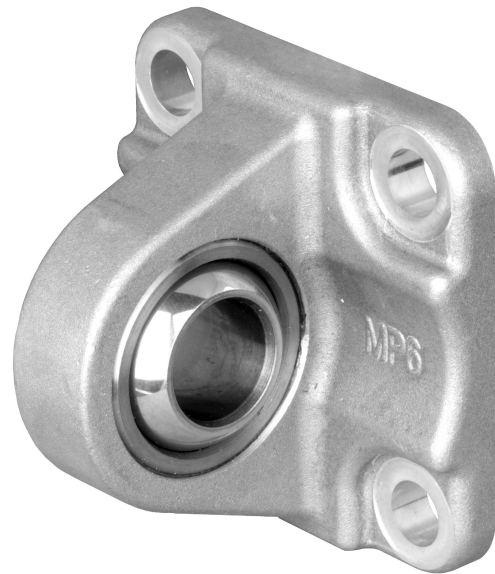

### Technical data

Industry	Industrial
Version	With ball joint and foot
Standardization	ISO 6431
Piston diameter	40 mm
Swivel bearing Ø	12 mm
Weight	0.1 kg

### Material

Housing material	Aluminum
Screws material	Galvanized Steel
Bearing material	Stainless Steel
Bearing material, inner ring	Stainless Steel
Bearing material, outer ring	Brass with PTFE coating
Part No.	3663604000

# Rear eye MP6, Series CM1

3663604000

Rear eye

2023-10-25

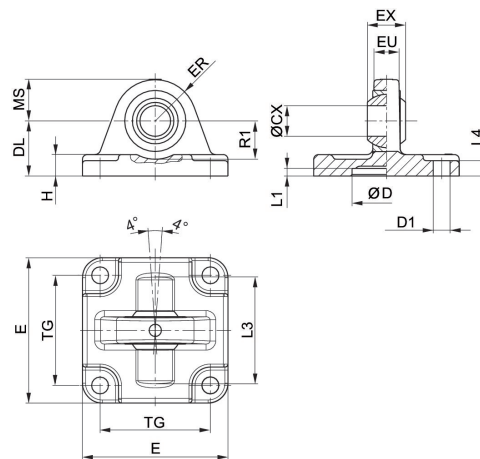

Scope of delivery: clevis incl. mounting screws

Piston Ø	Part No.	ØCX H7	ØD H11	ØD1 H13	DL ±0,2	E	EX -0,1	ER	EU
25	3663602000	10	18	5,5	20	40	9	14	8
32	3663603000	10	20	5,5	22	46	9	15	8
40	3663604000	12	30	6,6	28	55	12	17	9,5
52,5	3663605000	12	40	6,6	28	62	12	17	9,5
63	5220163442	10	-	7,5	29	45	14	15	10,5
75	3663606000	16	55	9	36	80	16	25	12,5
80	5220363442	12	-	10	26	65	16	18	12
80	3663608000	16	70	9	38	94	16	28	12,5
85, 95	5220463442	16	-	10	30	75	21	22	15
100	3663610000	20	90	11	43	114	20	35	16
115	5220563442	16	-	12	37,5	95	21	25	15

Piston Ø	H	L1 min.	L3	L4	MS -0,5	R1 min.	TG
25	6	3	-	3	14	-	26
32	6	0,5	42	6	15	16	32
40	8	0,5	48	8	17	16	32
52,5	9	0,5	55	9	17	18	46
63	8	-	-	-	-	-	33
75	11	0,5	70	11	25	21	59
80	10	-	-	-	-	-	49
80	12	0,5	80	12	28	21	73
85, 95	10	-	-	-	-	-	59
100	15	0,5	100	15	35	28	90
115	12	-	-	-	-	-	75