

AVENTICS Series MS01 Pneumatic position monitoring

The AVENTICS Series MS01 is a pneumatic position monitoring that can be integrated into every machine controller as a block solution with the CD01 valve system, which means minimal assembly and installation effort for the user. The measuring system can be mounted on a plastic base plate with a push-in fitting or an aluminium base plate with thread connection. This ensures a solid construction according to ISO standard 15407-1.



Technical data

Industry	Industrial
Version	1x
Version	MS01-AL test block, variant II, with 5/2-directional valve
Standards	ISO 15407-1
Standards	26 mm
Length	93.1 mm
Grid dimension	27.1 mm
Cleaning pressure option	permanent cleaning pressure
Compressed air connection standard	according to ISO 228-1
Compressed air connection input	G 3/8
Compressed air connection, exhaust	G 1/8
Compressed air connection output	G 1/4
Compressed air connection pilot air exhaust	G 1/8
Min. working pressure	4 bar
Max. working pressure	10 bar
Min. ambient temperature	0 °C
Max. ambient temperature	50 °C
Min. medium temperature	0 °C
Max. medium temperature	50 °C

Medium	Compressed air
Max. particle size	5 µm
Min. oil content of compressed air	0 mg/m ³
Max. oil content of compressed air	0.1 mg/m ³
Protection class	IP65
Duty cycle	100 %
Operational voltage DC	24 V
Voltage tolerance DC	-10% / +10%
Valve voltage tolerance	-10% / +10%
Min. detection distance	0.01 mm
Max. detection distance	0.3 mm
Electrical connection for test module	Plug
Electrical connection for test module	M12
Electrical connection for test module	5-pin
Electrical connection	Plug
Electrical connection	form C
Weight	1.64 kg
Material end plate	Aluminum
Surface end plate	Acrylonitrile butadiene rubber
Material front cover	Die-cast aluminum
Part No.	R412011191

Technical information

The pressure regulator is preset at [[3] bar].

Expansion options available for pilot valves.

The pressure dew point must be at least 15 °C less than ambient and medium temperature and may not exceed 3 °C.

The oil content of compressed air must remain constant during the life cycle.

Use only the approved oils from AVENTICS. Further information can be found in the “Technical information” document (available in <https://www.emerson.com/en-us/support>).

Dimensions

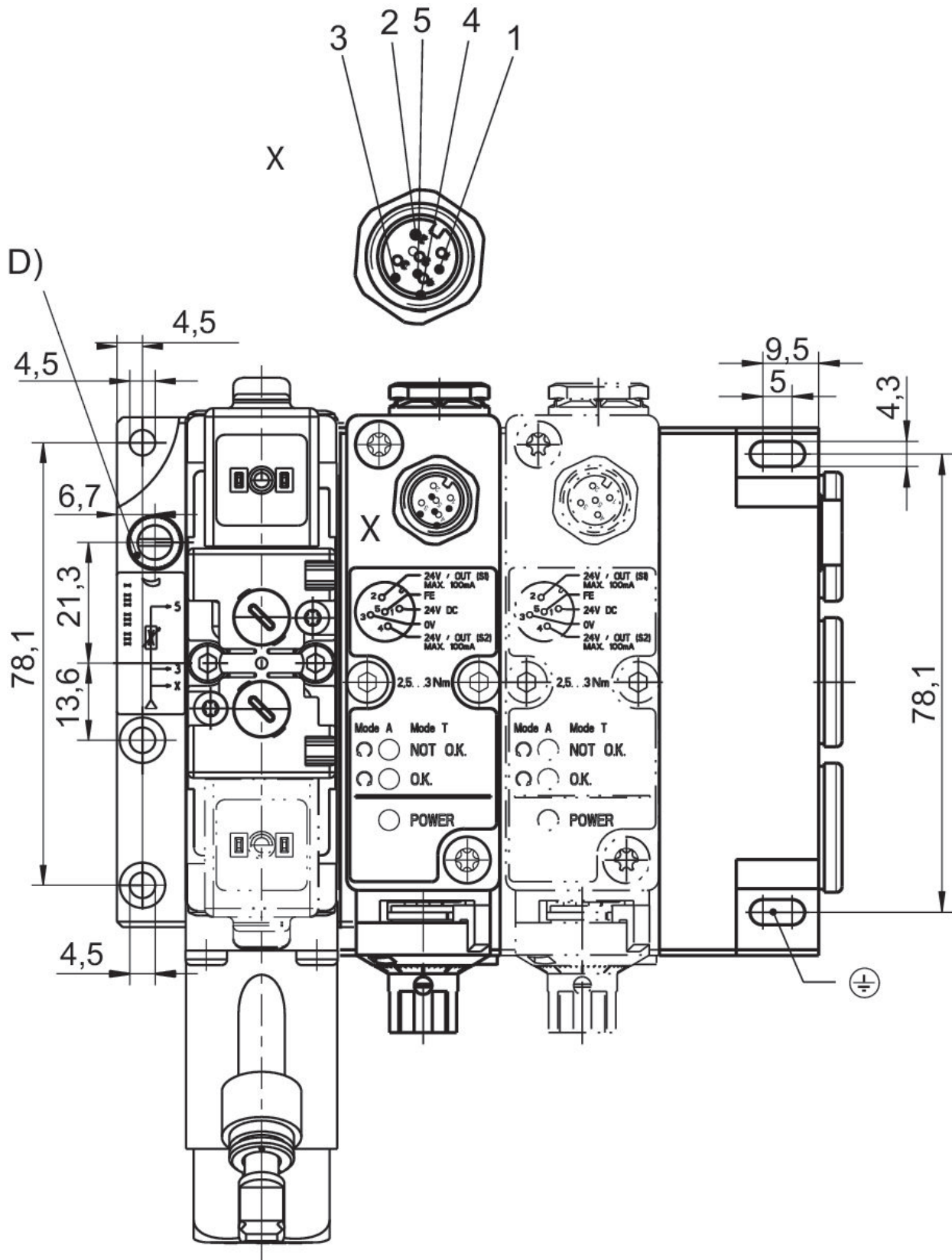

D = Throttle (cleaning pressure)

M12 contact assignment: contact 1: 24 V DC contact 2: output signal 24 V DC, S1 (working pressure), max. 100 mA contact 3: 0 V contact 4: output signal 24 V DC, S2 (testing), max. 100 mA contact 5: FE

Dimensions

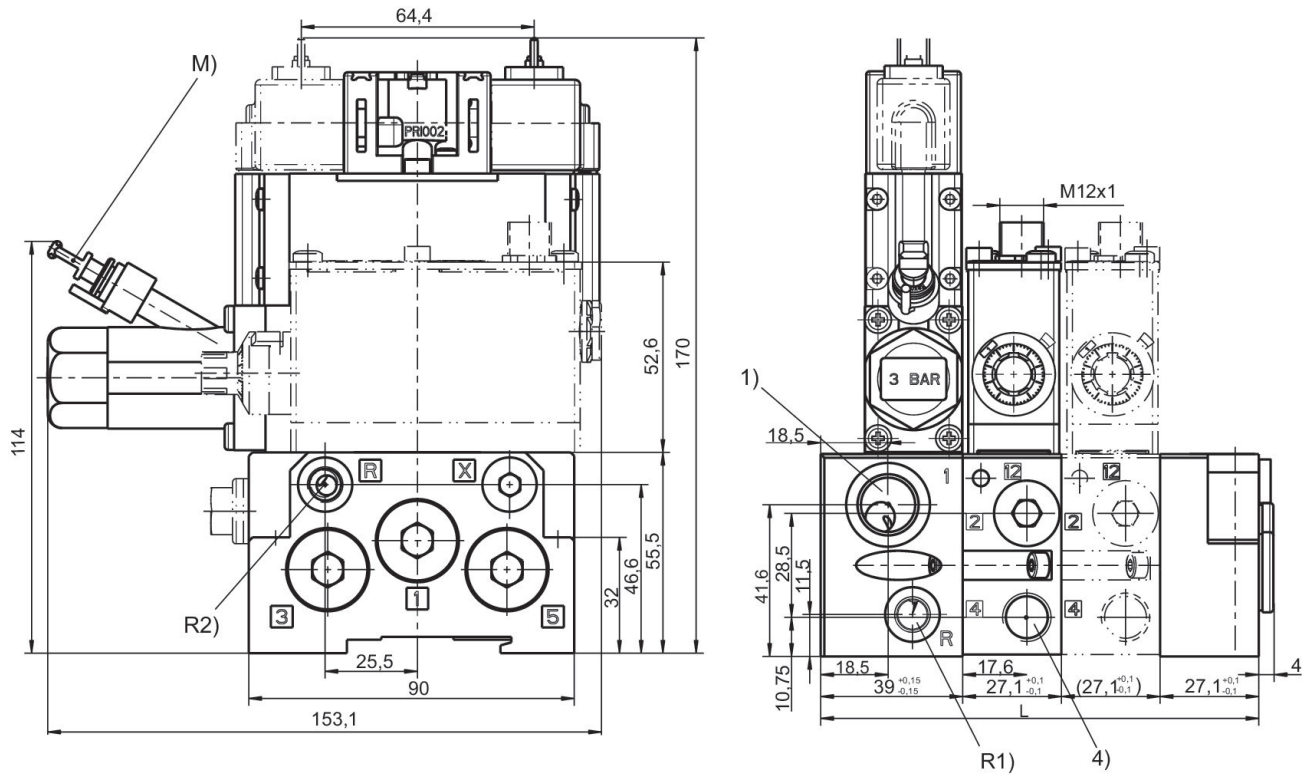

1) Operating pressure

4) Port 4 (to nozzle)

R1) Test module exhaust/sealing air connection (max. [[1] bar]) R2) Pilot control exhaust

M) Push-in fitting for plastic tubing Ø 6x1 of the pressure gauge

L = length