

Mini slide, Series MSC-MG-EM

R480643775

AVENTICS
Series
MSC Guide
cylinders

2024-04-06

AVENTICS Series MSC Guide cylinders

The AVENTICS Series MSC mini slides have a compact design, require minimal installation space and can be optimally configured for virtually any automated handling task. A wide range of configuration options make the mini slide a truly universal handling component. Precise and reliable operation, coupled with a custom configuration and tailored to the specific application – these attributes allow the mini slides to assume the actuator role in efficient handling. The Series MSC offers high torque absorption and maximum stability. In addition, it provides technical features that guarantee optimally adjusted functions and maintenance-friendly processes. Fast, secure and efficiently connected with the special Easy-2-Combine Interface, the mini slides can be combined with the other components of a handling system without additional mounting plates.

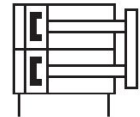

Technical data

Industry	Industrial
Note	Scope of delivery: incl. centering rings
Piston Ø	20 mm
Stroke	20 mm
Functional principle	Double-acting
Easy2Combine	capable
double piston	with double piston
Port	G 1/8
Cushioning	Elastic with metal end stop
Repetitive precision	0,02 mm
Min. working pressure	3 bar
Max. working pressure	10 bar
Min. ambient temperature	0 °C
Max. ambient temperature	60 °C
Medium	Compressed air
Retracting piston force, theoretical	297 N
Extracting piston force, theoretical	396 N
Max. speed	0.8 m/s
Cushioning length	3.05 mm

Mini slide, Series MSC-MG-EM

R480643775

AVENTICS
Series
MSC Guide
cylinders

2024-04-06

Cushioning energy	0.3 J
Min. oil content of compressed air	0 mg/m ³
Max. oil content of compressed air	1 mg/m ³
Max. particle size	5 µm
Pressure for determining piston forces with integrated ball rail guide	6,3 bar with integrated ball rail guide
Weight	1.42 kg

Material

Housing material	Aluminum
Surface housing	anodized
Material piston rod	Stainless Steel
Material front plate	Aluminum
Surface front plate	anodized
Seal material	Polyurethane
Material ball rail table	Aluminum
Surface ball rail table	anodized
Material guide rail	Steel, chrome-plated
Surface guide rail	hardened
Material centering rings	Stainless Steel
Part No.	R480643775

Technical information

Repetitive precision after 100 consecutive strokes: 0,02 mm

Base with air connections at the back and sides

Intermediate strokes can be configured.

Scope of delivery: incl. centering rings

R1 = stroke setting range for forward stroke

R2 = stroke setting range for return stroke

Ø 8 has a different reference plane.

The pressure dew point must be at least 15 °C less than ambient and medium temperature and may not exceed 3 °C.

The oil content of compressed air must remain constant during the life cycle.

Use only the approved oils from AVENTICS. Further information can be found in the "Technical information" document (available in <https://www.emerson.com/en-us/support>).

Dimensions

Mini slide, Series MSC-MG-EM

R480643775

MSC-12

AVENTICS
Series
MSC Guide
cylinders

2024-04-06

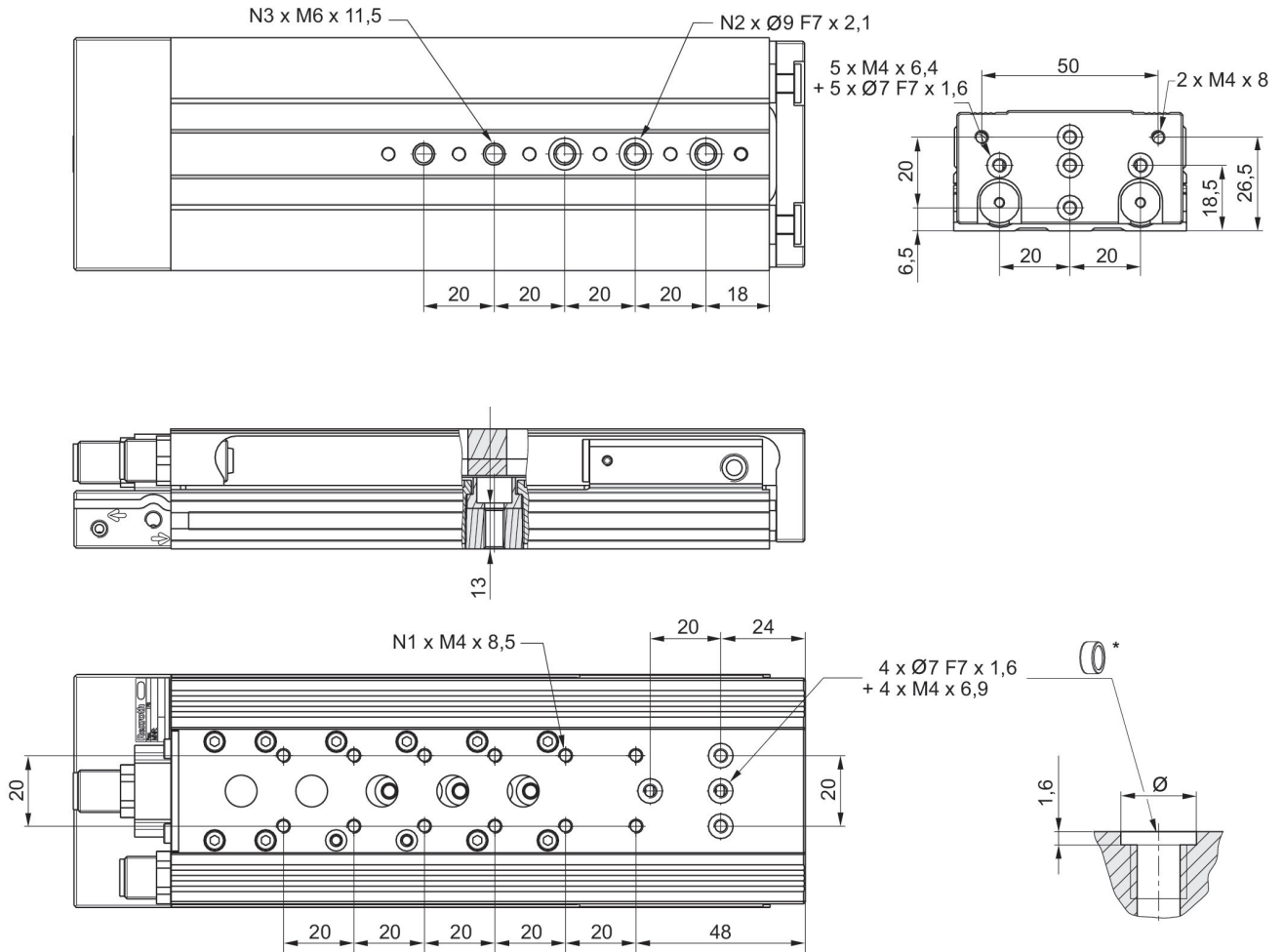

* = centering rings

Part No.	Piston \varnothing	S	N1	N2	N3
R480643760	12	10	2	2	2
R480643761	12	20	2	2	2
R480643762	12	30	2	2	2
R480643763	12	40	2	2	2
R480643764	12	50	4	3	3
R480643765	12	80	6	3	5
R480643766	12	100	8	3	5

S = stroke

Mini slide, Series MSC-MG-EM

R480643775

AVENTICS
Series
MSC Guide
cylinders

2024-04-06

Dimensions

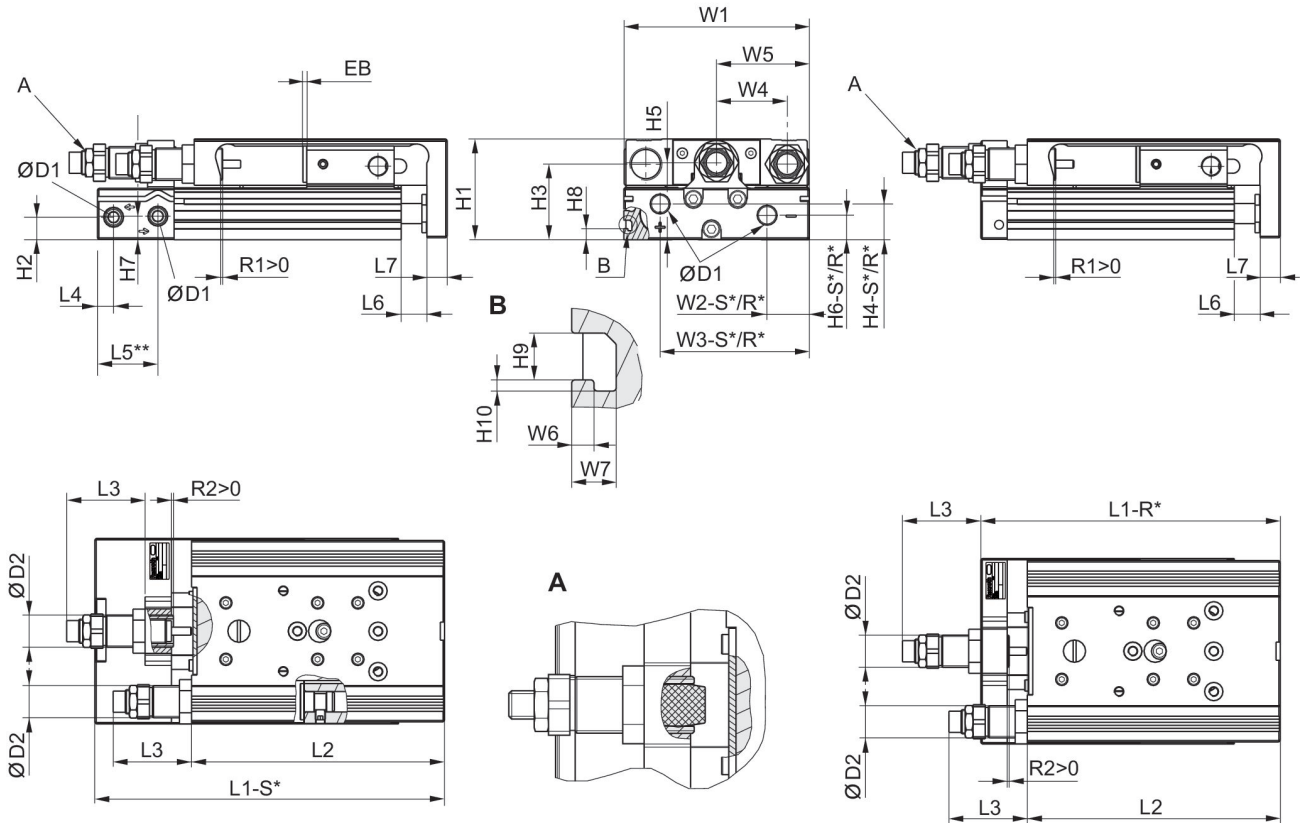

R*: base with air connections only at the back
S*: base with air connections at the back and sides
** Ø 8 has a different reference plane.

Dimensions

Piston Ø	Ø D1	Ø D2	H1	H2	H3	H4-R	H4-S	H5	H6-R
8	M5	M10x1	28	9.6	20.5	-	7.5	19.5	-
12	M5	M12x1	34	5.7	25	11.2	11.2	24.5	5.7
16	M5	M12x1	40	7.2	29	12.2	12.2	31	7.7
20	G 1/8	M16x1,5	50	11.2	37.5	17.3	17.3	38.2	11.7
25	G 1/8	M18x1,5	60	14.2	44	15.5	22.9	46.5	13.2

Piston Ø	H6-S	H7	H8	H9	H10	L3 max.	L4	L5 2)	L6
8	5.5	18	-	-	-	27.8	9.8	-	1.9
12	5.7	8.3	-	-	-	31.8	7.2	22.5	2
16	7.7	11.2	-	-	-	30	6.5	17.7	2
20	12.2	11.7	5.5	4.2	1	43.7	8	30	2.1
25	21.7	16.2	6.9	5.2	1.5	41.9	9	31	2.1

Mini slide, Series MSC-MG-EM

R480643775

AVENTICS
Series
MSC Guide
cylinders

Piston Ø	L7	W1	W2-R	W2-S	W3-R	W3-S	W4	W5	W6
8	6	50.2	–	19.3	–	30.5	18	W1/2	–
12	8	66	28.8	28.8	53	53	24.5	W1/2	–
16	10	76	31	31	60.5	60.5	30	W1/2	–
20	10	92	10	21	74	74	35	W1/2	2
25	12	112	11	14	92	92	44	W1/2	2.5

Piston Ø	W7
8	–
12	–
16	–
20	4
25	4.8

Weight of moving parts [kg]

Piston Ø	S=10	S=20	S=30	S=40	S=50	S=80	S=100	S=125	S=150
8	0.165	0.165	0.165	0.165	0.195	0.265	–	–	–
12	0.28	0.28	0.28	0.28	0.315	0.403	0.46	–	–
16	0.375	0.375	0.375	0.4	0.45	0.615	0.65	0.725	0.765
20	0.655	0.655	0.655	0.69	0.765	0.985	1.035	1.2	1.29
25	1.1	1.1	1.1	1.1	1.225	1.45	1.625	1.885	2.085

Piston Ø	S=200
8	–
12	–
16	–
20	1.54
25	2.445

Stroke-dependent dimensions

Piston Ø	S=10 EB	S=20 EB	S=30 EB	S=40 EB	S=50 EB	S=80 EB	S=100 EB	S=10 L1-R	S=20 L1-R
8	32	22	12	2	2	2	–	–	–
12	32	22	12	2	2	2	2	111	111
16	22	12	2	2	2	2	2	103.5	103.5
20	22	12	2	2	2	2	2	115	115
25	32	22	12	2	2	2	2	138.5	138.5

Piston Ø	S=30 L1-R	S=40 L1-R	S=50 L1-R	S=80 L1-R	S=100 L1-R	S=10 L1-S	S=20 L1-S	S=30 L1-S	S=40 L1-S
8	–	–	–	–	–	101.7	101.7	101.7	101.7
12	111	111	126	172	192	127.9	127.9	127.9	127.9
16	103.5	113.5	128.5	174.5	194.5	114.4	114.4	114.4	124.4
20	115	125	140	185	205	139.9	139.9	139.9	149.9

Mini slide, Series MSC-MG-EM

R480643775

AVENTICS
Series
MSC Guide
cylinders

Piston Ø	S=30 L1-R	S=40 L1-R	S=50 L1-R	S=80 L1-R	S=100 L1-R	S=10 L1-S	S=20 L1-S	S=30 L1-S	S=40 L1-S
25	138.5	138.5	151.5	197.5	217.5	162.2	162.2	162.2	162.2

2024-04-06

Piston Ø	S=50 L1-S	S=80 L1-S	S=100 L1-S	S=10 L2	S=20 L2	S=30 L2	S=40 L2	S=50 L2	S=80 L2
8	121.7	171.7	-	93.5	93.5	93.5	93.5	113.5	163.5
12	142.9	188.9	208.9	98.8	98.8	98.8	98.8	113.8	159.8
16	139.4	185.4	205.4	90.4	90.4	90.4	100.4	115.4	161.4
20	164.9	209.9	229.9	100.5	100.5	100.5	110.5	125.5	170.5
25	175.2	221.2	241.2	121.5	121.5	121.5	121.5	134.5	180.5

Piston Ø	S=100 L2	S=10 R1 max.	S=20 R1 max.	S=30 R1 max.	S=40 R1 max.	S=50 R1 max.	S=80 R1 max.	S=100 R1 max.	S=10 R2 max.
8	-	4.2	4.2	4.2	4.2	4.2	4.2	-	4.1
12	179.8	5.7	5.7	5.7	5.7	5.7	5.7	5.7	2
16	181.4	8.7	8.7	8.7	8.7	8.7	8.7	8.7	1.5
20	190.5	12.4	12.4	12.4	12.4	12.4	12.4	12.4	1.5
25	200.5	11.5	11.5	11.5	11.5	10.5	11.5	11.5	7.5

Piston Ø	S=20 R2 max.	S=30 R2 max.	S=40 R2 max.	S=50 R2 max.	S=80 R2 max.	S=100 R2 max.
8	4.1	4.1	4.1	4.1	4.1	-
12	2	2	2	10	12	12
16	1.5	1.5	1.5	6	7	5.7
20	1.5	1.5	11.5	9.5	14	14
25	7.5	7.5	7.5	3.3	7.5	9.2

Mini slide, Series MSC-MG-EM

R480643775

MSC-25

AVENTICS
Series
MSC Guide
cylinders

2024-04-06

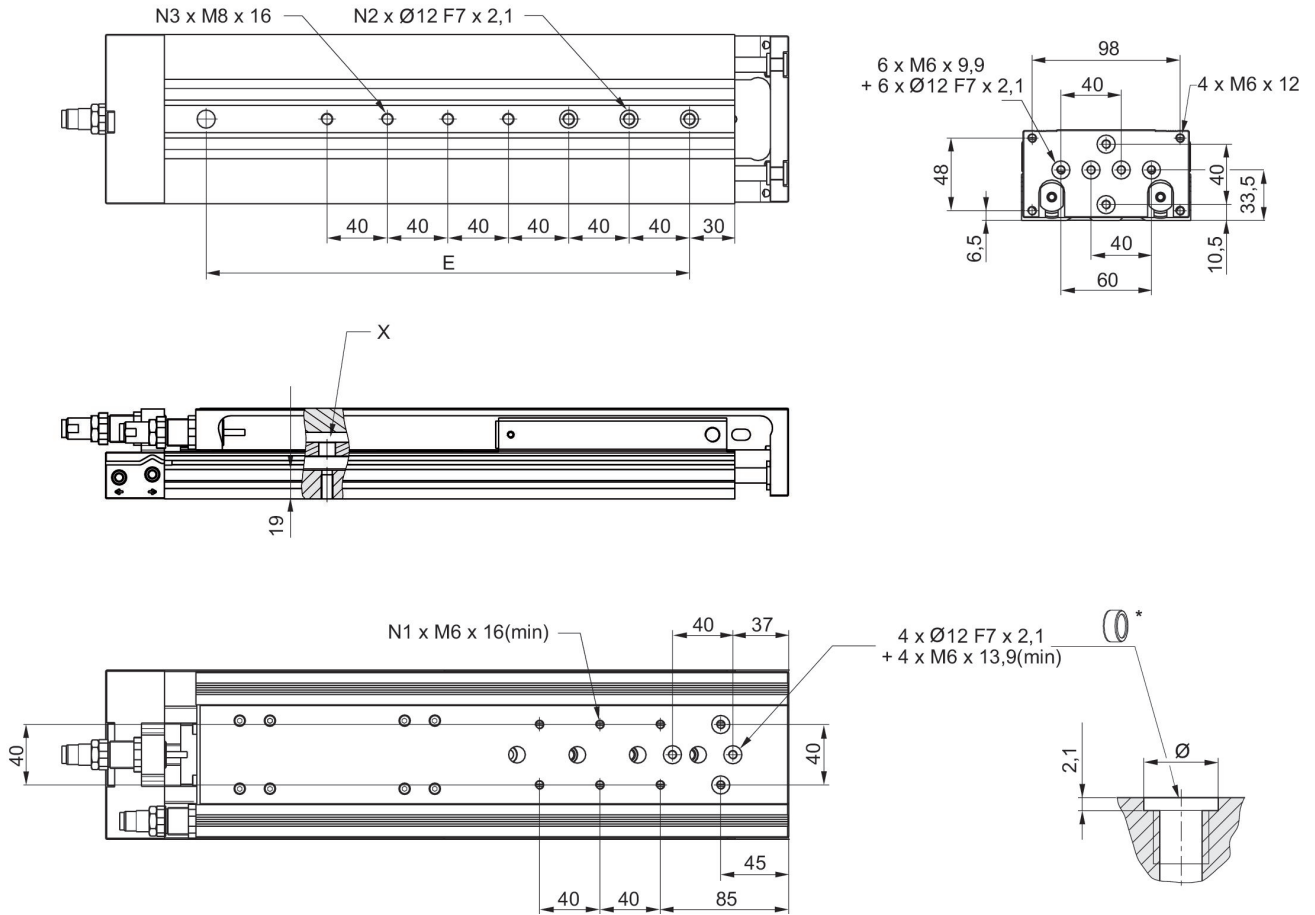

* = centering rings

Part No.	Piston Ø	S	N1	N2	N3	X
R480643781	25	10	2	2	2	1)
R480643782	25	20	2	2	2	1)
R480643783	25	30	2	2	2	1)
R480643784	25	40	2	2	2	
R480643785	25	50	4	2	2	
R480643786	25	80	4	3	3	
R480643787	25	100	4	3	3	

S = stroke

1) Access to the through hole only after removal of the stroke limitation bolts

Mini slide, Series MSC-MG-EM

R480643775

MSC-20

AVENTICS
Series
MSC Guide
cylinders

2024-04-06

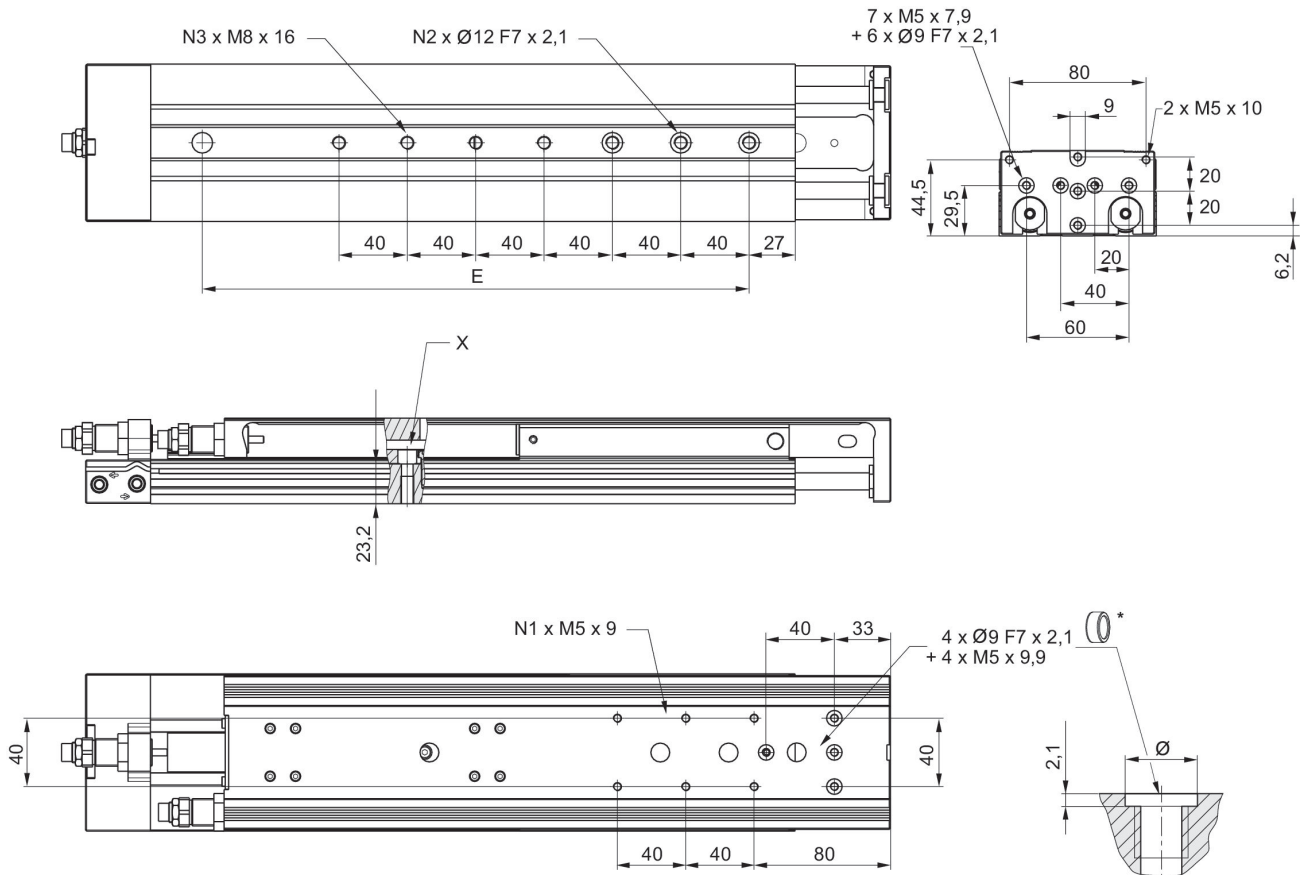

* = centering rings

Part No.	Piston Ø	S	N1	N2	N3	X
R480643774	20	10	2	2	2	1)
R480643775	20	20	2	2	2	1)
R480643776	20	30	2	2	2	
R480643777	20	40	2	2	2	
R480643778	20	50	2	2	2	
R480643779	20	80	4	3	3	
R480643780	20	100	4	3	3	

S = stroke

1) Access to the through hole only after removal of the stroke limitation bolts

Mini slide, Series MSC-MG-EM

R480643775

MSC-16

AVENTICS
Series
MSC Guide
cylinders

2024-04-06

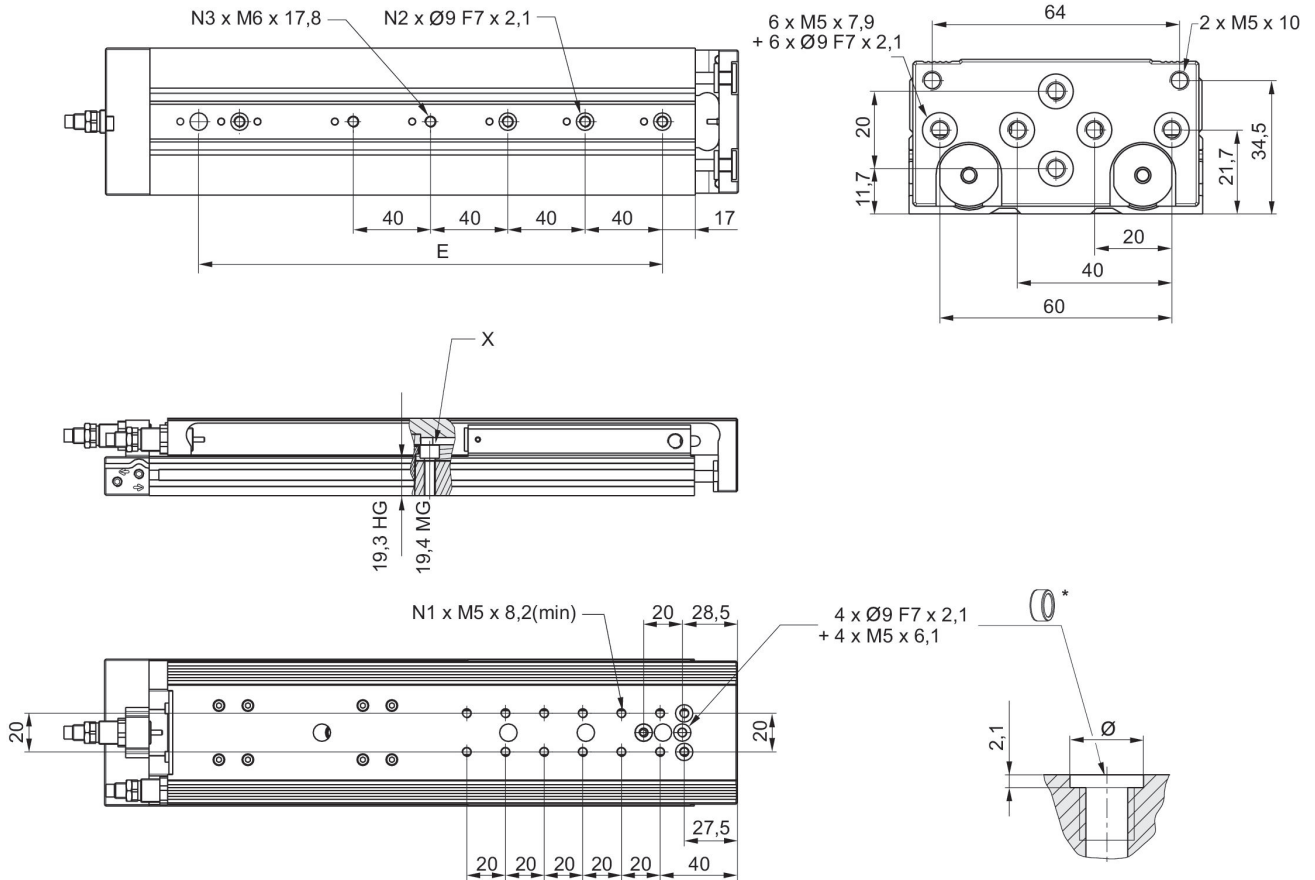

* = centering rings

Part No.	Piston Ø	S	N1	N2	N3	X
R480643767	16	10	2	2	2	1)
R480643768	16	20	2	2	2	1)
R480643769	16	30	2	2	2	
R480643770	16	40	4	2	2	
R480643771	16	50	4	2	2	
R480643772	16	80	6	3	3	
R480643773	16	100	8	3	3	

S = stroke

1) Access to the through hole only after removal of the stroke limitation bolts

Mini slide, Series MSC-MG-EM

R480643775

AVENTICS
Series
MSC Guide
cylinders

2024-04-06

MSC-08

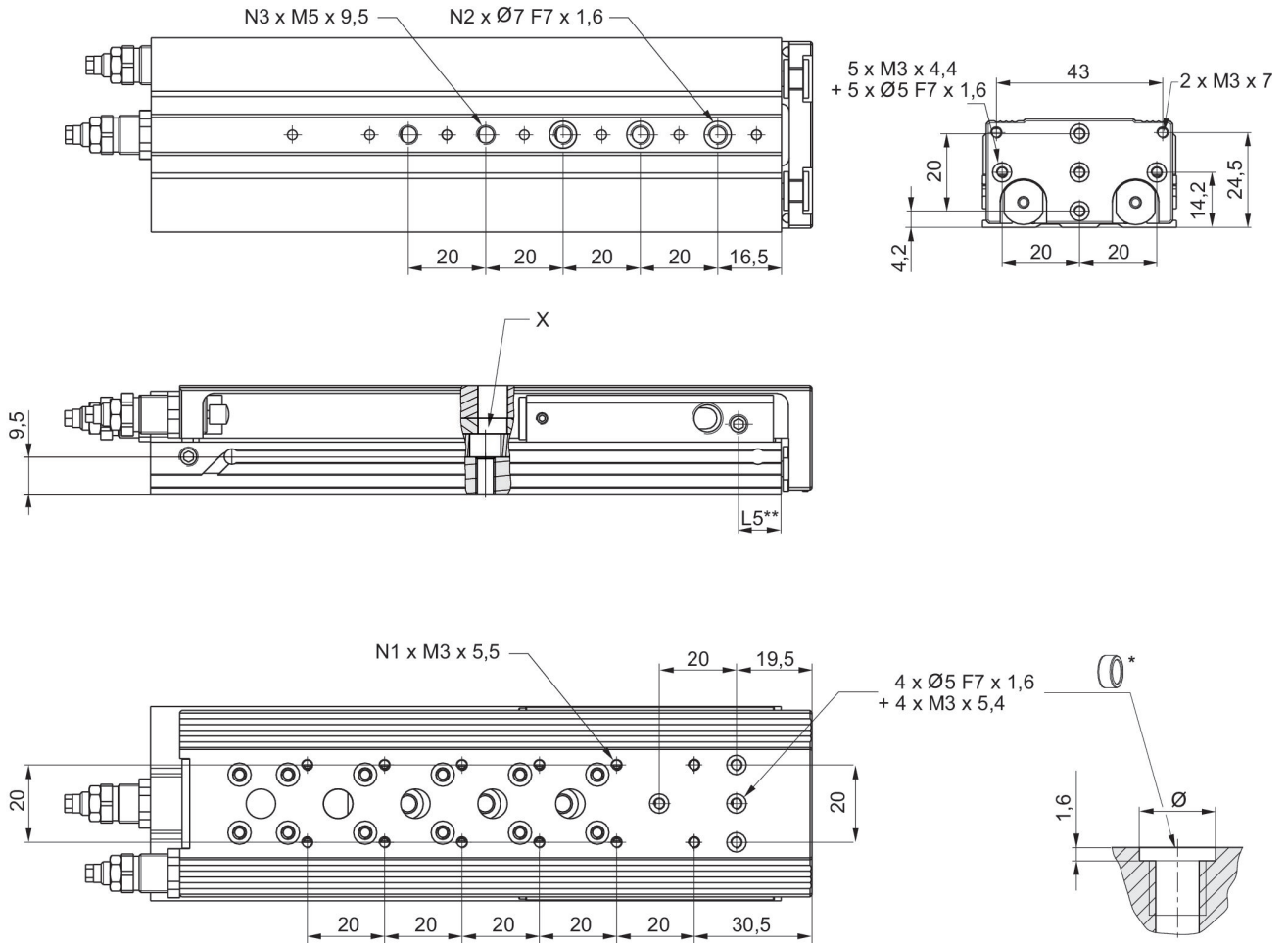

* = centering rings

** $\varnothing 8$ has a different reference plane.

Part No.	Piston \varnothing	S	N1	N2	N3	L5	X
R480643754	8	10	4	2	2	11	
R480643755	8	20	4	2	2	11	
R480643756	8	30	4	2	2	11	
R480643757	8	40	4	2	2	11	
R480643758	8	50	4	3	3	11	1)
R480643759	8	80	8	3	5	11	

S = stroke

1) Access to the through hole only after removal of the stroke limitation bolts

Mini slide, Series MSC-MG-EM

R480643775

AVENTICS
Series
MSC Guide
cylinders

2024-04-06

Correction factor (a, d)

vertical

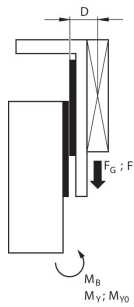

stat.	$M_{B0} = (F_G + F) \cdot D$
dyn.	$M_B = F_G \cdot D$

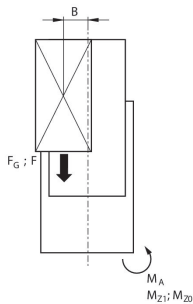

stat.	$M_{A0} = (F_G + F) \cdot B$
dyn.	$M_A = F_G \cdot B$

dyn.	$\frac{M_A}{M_1} + \frac{M_B}{M_2} \leq 1$
stat.	$\frac{M_{A0}}{M_{Z0}} + \frac{M_{B0}}{M_{Y0}} \leq 1$

$F = m \cdot a$ $F_G = m \cdot g$ $a = 1250 \cdot V^2 / H$

F = deceleration force [N] F_G = force due to weight [N] m = load mass [kg] a = deceleration [m/s²] g = gravitational acceleration 9,81 [m/s²] V = velocity [m/s] H = stroke length of shock absorber [mm]

Correction factor (a, d)

horizontal

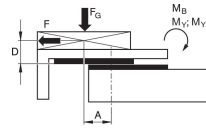

stat.	$M_{B0} = F_G \cdot A + F \cdot D$
dyn.	$M_B = F_G \cdot A$

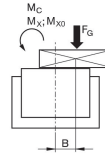

stat.	$M_{C0} = F_G \cdot B$
dyn.	$M_C = F_G \cdot B$

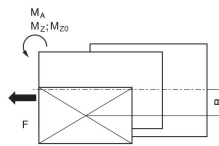

stat.	$M_{A0} = F \cdot B$
dyn.	$M_A = 0$

dyn.	$\frac{M_A}{M_1} + \frac{M_B}{M_2} + \frac{M_C}{M_3} \leq 1$
stat.	$\frac{M_{A0}}{M_{Z0}} + \frac{M_{B0}}{M_{Y0}} + \frac{M_{C0}}{M_{X0}} \leq 1$

$F = m \cdot a$ $F_G = m \cdot g$ $a = 1250 \cdot V^2 / H$

F = deceleration force [N] F_G = force due to weight [N] m = load mass [kg] a = deceleration [m/s²] g = gravitational acceleration 9,81 [m/s²] V = velocity [m/s] H = stroke length of shock absorber [mm]

Correction factor (a, d)

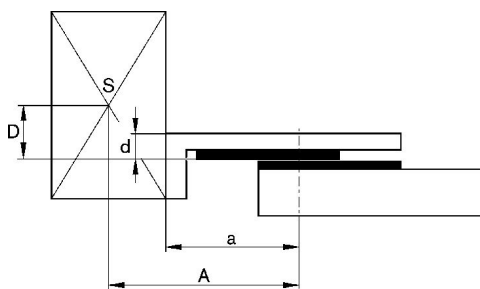

Maximum moving mass

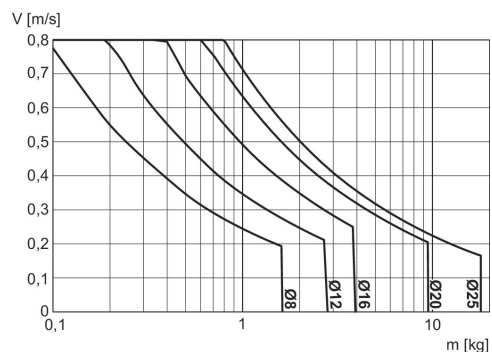

V = velocity [m/s]
m = mass

Mini slide, Series MSC-MG-EM

R480643775

AVENTICS
Series
MSC Guide
cylinders

2024-04-06

Correction factor for required speed:
retracting and extending, horizontal

Correction factor for required speed:
extending, vertical, downwards

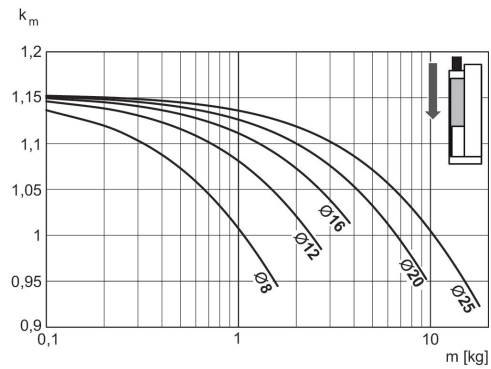
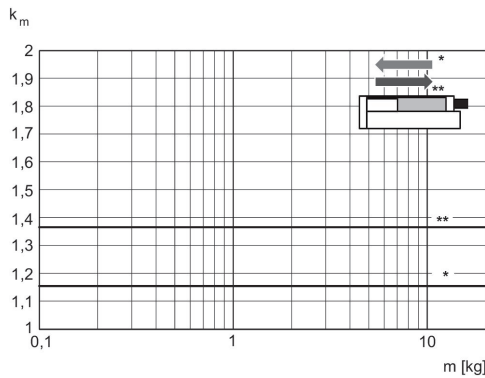

* retracting
** extracting
 $V = s/1000 \cdot t \cdot km$
V = velocity [m/s]
S = stroke

$V = s/1000 \cdot t \cdot km$
V = velocity [m/s]
S = stroke [mm]
t = time [s] for one stroke
m = mass

Correction factor for required speed:
retracting, vertical, downwards

Correction factor for required speed:
retracting, vertical, upwards

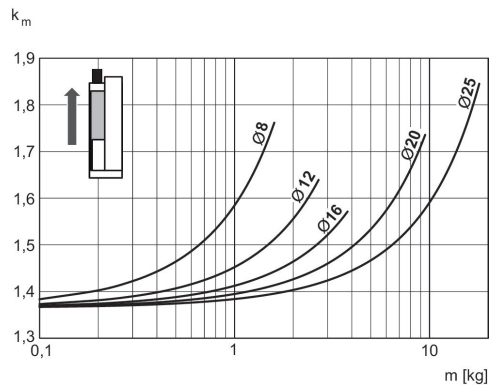
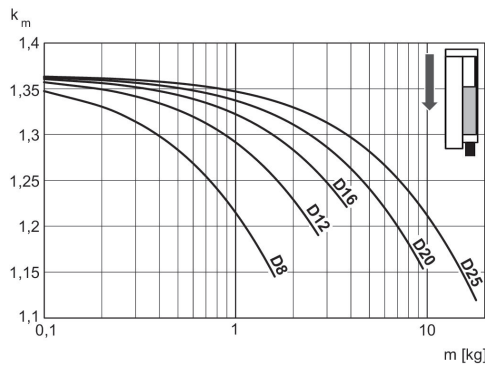

$V = s/1000 \cdot t \cdot km$
V = velocity [m/s]
S = stroke [mm]
t = time [s] for one stroke
m = mass

$V = s/1000 \cdot t \cdot km$
V = velocity [m/s]
S = stroke [mm]
t = time [s] for one stroke
m = mass

Mini slide, Series MSC-MG-EM

R480643775

AVENTICS
Series
MSC Guide
cylinders

2024-04-06

Correction factor for required speed: **Max. extracting speed**
extending, vertical, upwards

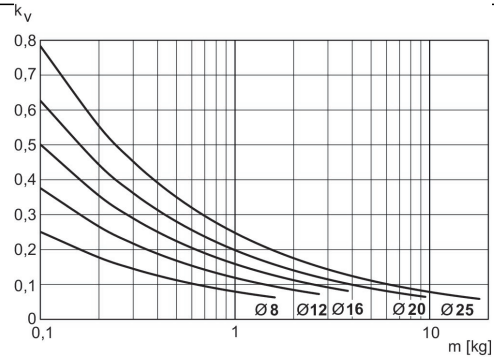
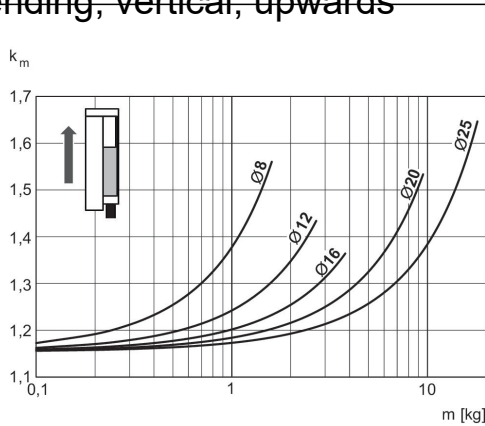

$V = \sqrt{s \cdot kv}$
V = velocity [m/s]
S = stroke [mm]
m = mass

$V = s/1000 \cdot t \cdot km$
V = velocity [m/s]
S = stroke [mm]
t = time [s] for one stroke
m = mass

Load capacity

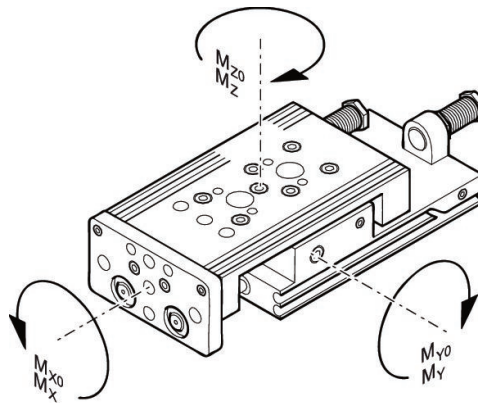

M = max. permissible torque

Correction factor (a)

Part No.	Piston Ø	Stroke	a [mm] 1)	d [mm] 2)	Mx0 Static moment M [Nm]	My0 Static moment M [Nm]	Mz0 Static moment M [Nm]	Mx Dynamic moment M [Nm]	My Dynamic moment M [Nm]
R480643754	8	10	69.5	12	5.8	5.9	5.9	1.1	1.7
R480643755	8	20	69.5	12	5.8	5.9	5.9	1.1	1.7
R480643756	8	30	69.5	12	5.8	5.9	5.9	1.1	1.7
R480643757	8	40	69.5	12	5.8	5.9	5.9	1.1	1.7
R480643758	8	50	83	12	5.8	5.9	5.9	1.3	1.7
R480643759	8	80	121	12	8	14.6	14.6	1.3	3.7
R480643760	12	10	77	15	13.8	6.45	6.45	3.5	1.6
R480643761	12	20	77	15	13.8	6.45	6.45	3.5	1.6
R480643762	12	30	77	15	13.8	6.45	6.45	3.5	1.6
R480643763	12	40	77	15	13.8	6.45	6.45	3.5	1.6
R480643764	12	50	81	15	13.8	6.45	6.45	3.5	1.6

Mini slide, Series MSC-MG-EM

R480643775

AVENTICS
Series
MSC Guide
cylinders

Part No.	Piston Ø	Stroke	a [mm] 1)	d [mm] 2)	Mx0 Static moment M [Nm]	My0 Static moment M [Nm]	Mz0 Static moment M [Nm]	Mx Dynam-ic moment M [Nm]	My Dynam-ic moment M [Nm]
R480643765	12	80	117	15	17.3	15.6	15.6	5.2	3.5
R480643766	12	100	137	15	17.3	15.6	15.6	5.2	3.5
R480643767	16	10	65	15	31.6	11.95	11.95	6.5	3.2
R480643768	16	20	65	15	31.6	11.95	11.95	6.5	3.2
R480643769	16	30	65	15	31.6	11.95	11.95	6.5	3.2
R480643770	16	40	75	15	31.6	11.95	11.95	6.5	3.2
R480643771	16	50	86	15	31.6	11.95	11.95	7	3.2
R480643772	16	80	123	15	45	27.3	27.3	8.7	6.3
R480643773	16	100	144	15	45	27.3	27.3	8.7	6.3
R480643774	20	10	75	20	31.6	11.95	11.95	9.6	4
R480643775	20	20	75	20	31.6	11.95	11.95	9.6	4
R480643776	20	30	75	20	31.6	11.95	11.95	9.6	4
R480643777	20	40	75	20	31.6	11.95	11.95	9.6	4
R480643778	20	50	92	20	31.6	11.95	11.95	10	4
R480643779	20 20	80	125	20	45	27.3	27.3	11.7	8
R480643780	20	100	143	20	45	27.3	27.3	11.7	8
R480643781	25	10	85	24	87	24.5	24.5	22.9	6.6
R480643782	25	20	85	24	87	24.5	24.5	22.9	6.6
R480643783	25	30	85	24	87	24.5	24.5	22.9	6.6
R480643784	25	40	85	24	87	24.5	24.5	22.9	6.6
R480643785	25	50	102	24	87	24.5	24.5	15.3	6.6
R480643786	25	80	134	24	110	62.5	62.5	18.8	14.5
R480643787	25	100	152	24	110	62.5	62.5	18.8	14.5

Part No.	Mz Dynam-ic moment M [Nm]
R480643754	1.7
R480643755	1.7
R480643756	1.7
R480643757	1.7
R480643758	1.7
R480643759	3.7
R480643760	1.6
R480643761	1.6
R480643762	1.6
R480643763	1.6
R480643764	1.6
R480643765	3.5
R480643766	3.5
R480643767	3.2
R480643768	3.2
R480643769	3.2
R480643770	3.2
R480643771	3.2
R480643772	6.3

Mini slide, Series MSC-MG-EM

R480643775

AVENTICS
Series
MSC Guide
cylinders

2024-04-06

Part No.	Mz Dynamic moment M [Nm]
R480643773	6.3
R480643774	4
R480643775	4
R480643776	4
R480643777	4
R480643778	4
R480643779	8
R480643780	8
R480643781	6.6
R480643782	6.6
R480643783	6.6
R480643784	6.6
R480643785	6.6
R480643786	14.6
R480643787	14.6

Mini slide, Series MSC-MG-EM

R480643775

AVENTICS
Series
MSC Guide
cylinders

2024-04-06

Overview drawing

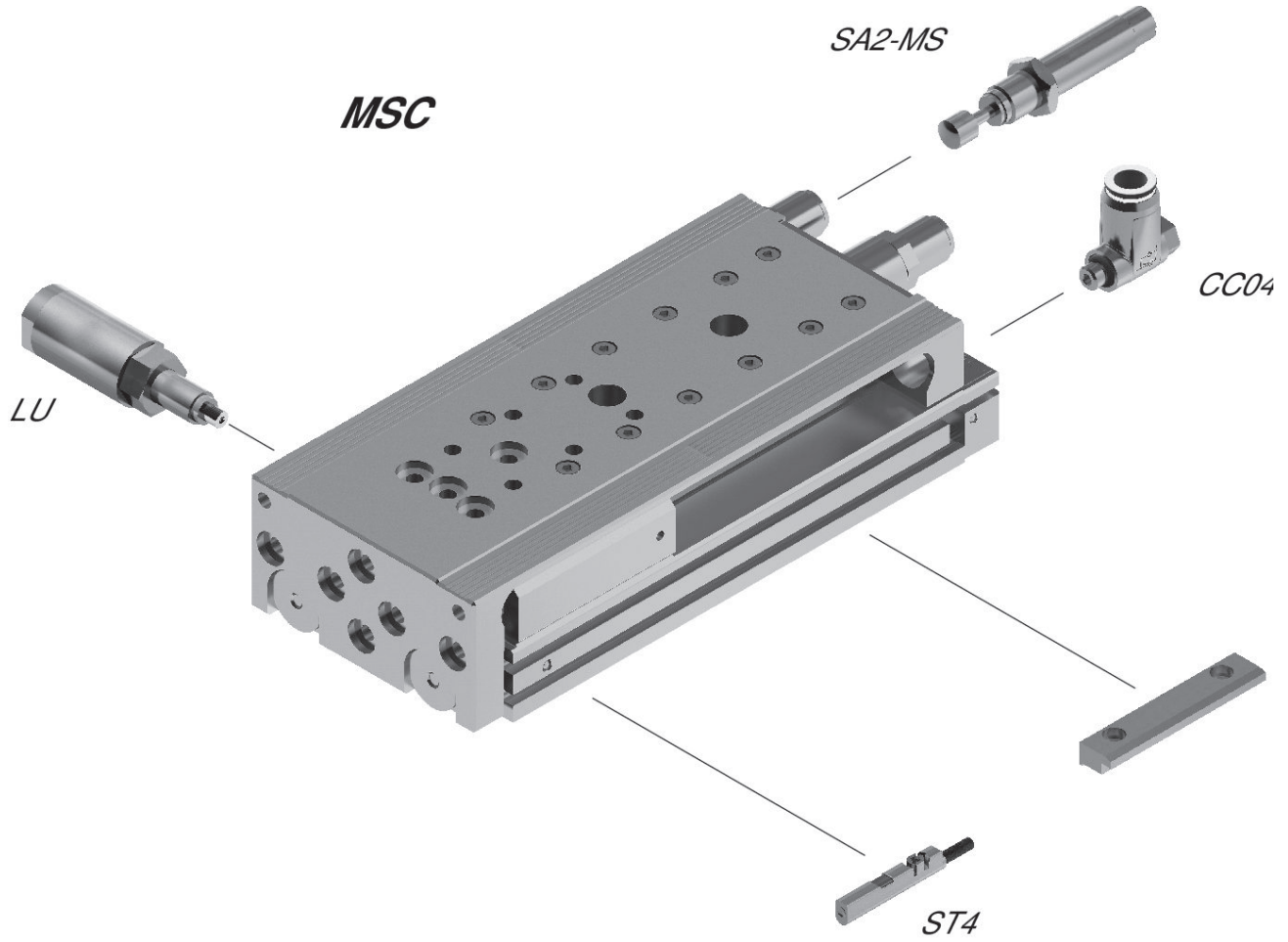

NOTE: This overview drawing is only for orientation to indicate where the various accessory parts can be fastened to the cylinder. The illustration has been simplified for this purpose. It is thus not possible to derive the dimensions from this overview.