

- Compact narrow design
- Precise load capacity
- Unlimited mounting options

AVENTICS Series MSN Guide cylinders

The AVENTICS Series MSN mini slides offer precise guidance without play in a very narrow package. With their wide variety of mounting and air supply options the Series allows for applications in virtually any position and location.

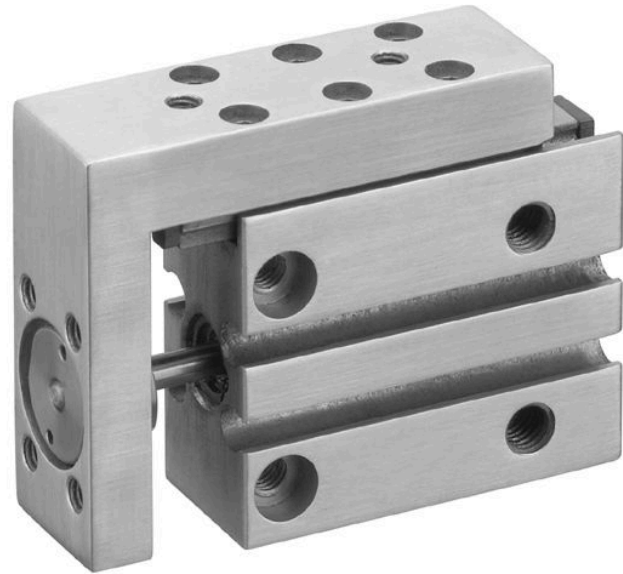

Technical data

Industry

Industrial

Note

Archive product: Do not use in new constructions!
narrow version

Piston Ø

16 mm

Stroke

15 mm

Functional principle

Double-acting

Port

M5

Cushioning

elastic

Min. working pressure

1 bar

Max. working pressure

10 bar

Min. ambient temperature

0 °C

Max. ambient temperature

60 °C

Medium

Compressed air

Retracting piston force, theoretical

95 N

Extracting piston force, theoretical

127 N

Max. speed

0.8 m/s

Cushioning energy

0.15 J

Min. oil content of compressed air

0 mg/m³

Max. oil content of compressed air

1 mg/m³

Max. particle size

5 µm

Mini slide, Series MSN

0821406514

Series MSN

2024-08-21

Pressure for determining piston forces with integrated ball rail guide	6,3 bar with integrated ball rail guide
Weight	0.262 kg

Material

Housing material	Aluminum
Surface housing	anodized
Material piston rod	Stainless Steel
Seal material	Polyurethane
Material ball rail table	Aluminum
Surface ball rail table	anodized
Material guide rail	Steel, chrome-plated
Surface guide rail	hardened
Part No.	0821406514

Technical information

The pressure dew point must be at least 15 °C less than ambient and medium temperature and may not exceed 3 °C.

The oil content of compressed air must remain constant during the life cycle.

Use only the approved oils from AVENTICS. Further information can be found in the "Technical information" document (available in <https://www.emerson.com/en-us/support>).

Dimensions

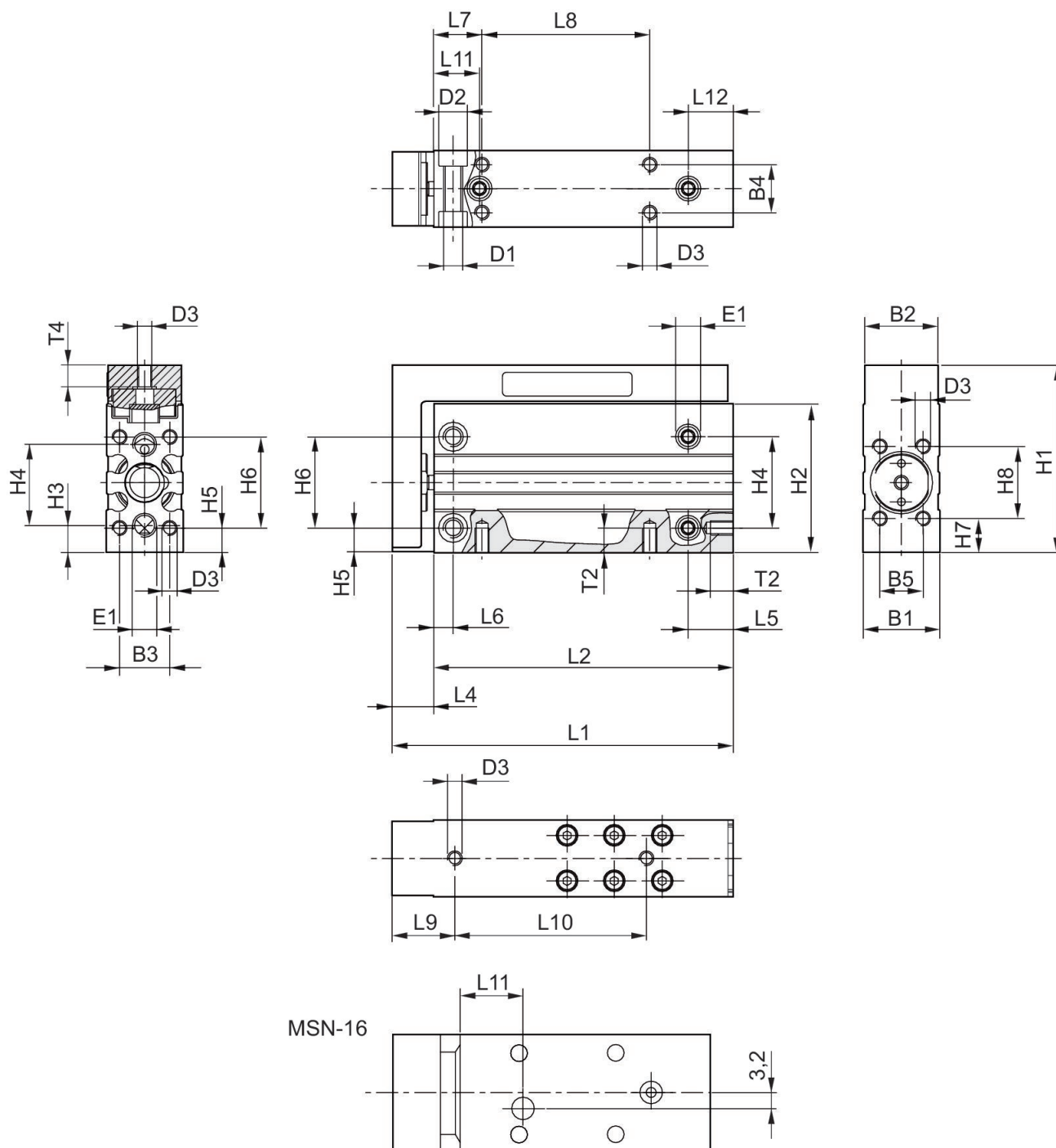

Dimensions

Piston Ø	B1	B2	B3	B4	B5	D1	D2	D3	E1 Compressed air connection
6	16	15.3	10.5	10	9	M4	6	M3	M5
10	20	19.3	13	13	11	M5	7.5	M4	M5

Mini slide, Series MSN

Series MSN

0821406514

2024-08-21

Piston Ø	B1	B2	B3	B4	B5	D1	D2	D3	E1 Compressed air connection
16	24	23.3	17	17	16	M5	7.5	M4	M5

Piston Ø	H1	H2	H3	H4	H5	H6	H7	H8
6	39	31	5.5	17	5	19	7	15
10	45	36	6.5	20	5	23	7.5	18
16	51	41	6	25	5.5	27	6	26

MSN-16

Part No.	Piston Ø	Stroke	L1	L2	L4	L5	L6	L7	L8
R452000852	16	5	66	52	14	12.5	5	12	20
R452000853	16	10	66	52	14	12.5	5	12	20
R452000854	16	15	76	62	14	12.5	5	12	30
R452000855	16	20	76	62	14	12.5	5	12	30
R452000856	16	25	86	72	14	12.5	5	12	40
R452000857	16	30	91	77	14	12.5	5	12	45

Part No.	L9	L10	L11	L12	T2	T4
R452000852	18	24	13	12.5	6	6
R452000853	18	35	13	12.5	6	6
R452000854	18	45	13.5	12.5	6	6
R452000855	18	50	13.5	12.5	6	6
R452000856	18	50	17.5	12.5	6	6
R452000857	18	55	17.5	12.5	6	6

MSN-10

Part No.	Piston Ø	Stroke	L1	L2	L4	L5	L6	L7	L8
R452000846	10	5	51.5	40	11.5	12.5	5	12	10
R452000847	10	10	56.5	45	11.5	12.5	5	12	14
R452000848	10	15	61.5	50	11.5	12.5	5	12	18
R452000849	10	20	66.5	55	11.5	12.5	5	12	24
R452000850	10	25	73.5	62	11.5	12.5	5	12	32
R452000851	10	30	78.5	67	11.5	12.5	5	12	35

Part No.	L9	L10	L11	L12	T2	T4
R452000846	15	14	11	9.5	6	5.5
R452000847	15	19	11	9.5	6	5.5
R452000848	15	25	11	9.5	6	5.5
R452000849	15	30	11	9.5	6	5.5
R452000850	15	40	12	10.5	6	5.5
R452000851	15	45	12	10.5	6	5.5

Mini slide, Series MSN

0821406514

Series MSN

2024-08-21

MSN-6

Part No.	Piston Ø	Stroke	L1	L2	L4	L5	L6	L7	L8
R452000840	6	5	46	37.5	8.5	10	4	10	10
R452000841	6	10	51	42.5	8.5	10	4	10	15
R452000842	6	15	56	47.5	8.5	10	4	10	20
R452000843	6	20	61	52.5	8.5	10	4	10	25
R452000844	6	25	66	57.5	8.5	10	4	10	30
R452000845	6	30	71	62.5	8.5	10	4	10	35

Part No.	L9	L10	L11	L12	T2	T4
R452000840	13	20	9.5	9.5	4.8	5
R452000841	13	20	9.5	9.5	4.8	5
R452000842	13	25	9.5	9.5	4.8	5
R452000843	13	30	9.5	9.5	4.8	5
R452000844	13	40	9.5	9.5	4.8	5
R452000845	13	40	9.5	9.5	4.8	5

Correction factor (a, d) vertical

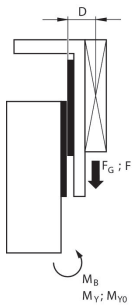

stat.	$M_{B0} = (F_G + F) \cdot D$
dyn.	$M_B = F_G \cdot D$

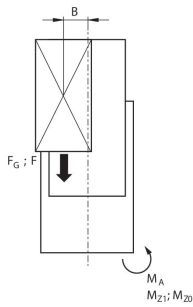

stat.	$M_{A0} = (F_G + F) \cdot B$
dyn.	$M_A = F_G \cdot B$

dyn.	$\frac{M_A}{M_1} + \frac{M_B}{M_2} \leq 1$
stat.	$\frac{M_{A0}}{M_{Z0}} + \frac{M_{B0}}{M_{Y0}} \leq 1$

$F = m \cdot a$ $F_G = m \cdot g$ $a = 1250 \cdot V^2 / H$
 F = deceleration force [N] F_G = force due to weight [N] m = load mass [kg] a = deceleration [m/s²] g = gravitational acceleration 9,81 [m/s²] V = velocity [m/s] H = stroke length of shock absorber [mm]

Correction factor (a, d) horizontal

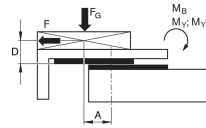

stat.	$M_{B0} = F_G \cdot A + F \cdot D$
dyn.	$M_B = F_G \cdot A$

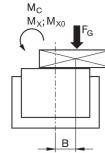

stat.	$M_{C0} = F_G \cdot B$
dyn.	$M_C = F_G \cdot B$

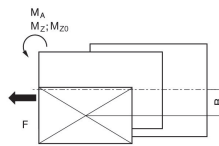

stat.	$M_{A0} = F \cdot B$
dyn.	$M_A = 0$

dyn.	$\frac{M_A}{M_1} + \frac{M_B}{M_2} + \frac{M_C}{M_3} \leq 1$
stat.	$\frac{M_{A0}}{M_{Z0}} + \frac{M_{B0}}{M_{Y0}} + \frac{M_{C0}}{M_{X0}} \leq 1$

$F = m \cdot a$ $F_G = m \cdot g$ $a = 1250 \cdot V^2 / H$
 F = deceleration force [N] F_G = force due to weight [N] m = load mass [kg] a = deceleration [m/s²] g = gravitational acceleration 9,81 [m/s²] V = velocity [m/s] H = stroke length of shock absorber [mm]

Max. permissible torque

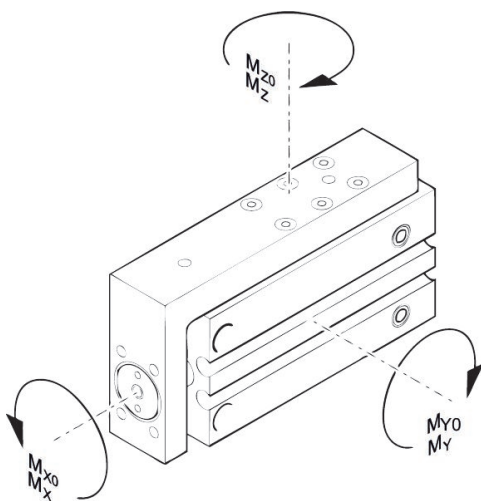

Maximum additionally moving mass (min. stroke, max. stroke) MSN - 6

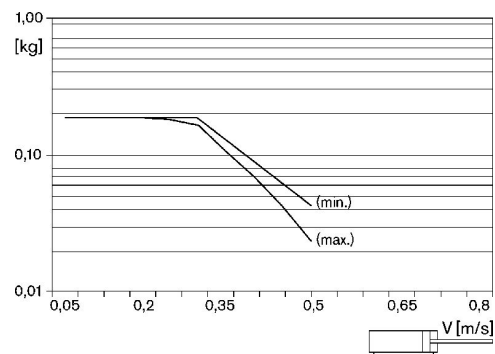

Maximum additionally moving mass
(min. stroke, max. stroke)

MSN - 10

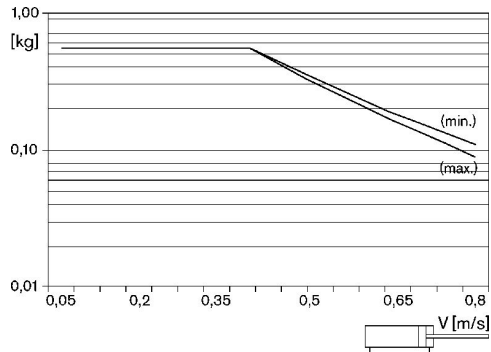

Maximum additionally moving mass
(min. stroke, max. stroke)

MSN-16

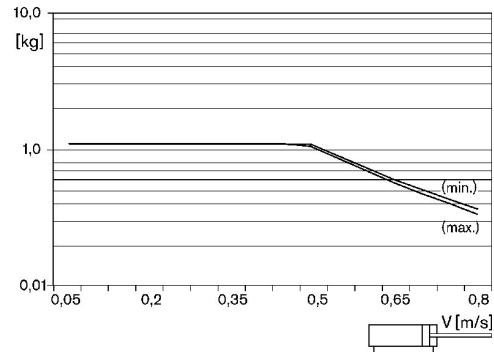

Correction factor (a, d)

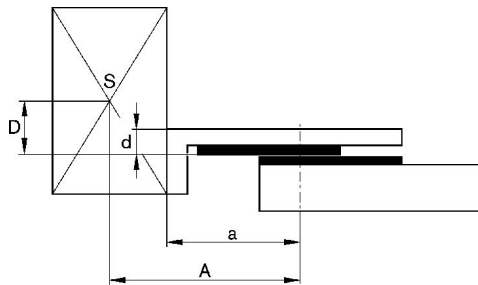

Correction factor (a, d)

Part No.	Piston Ø	Stroke	a [mm]	d [mm]	Mx0 Static moment M [Nm]	My0 Static moment M [Nm]	Mz0 Static moment M [Nm]	Mx Dynamic moment M [Nm]	My Dynamic moment M [Nm]
0821406500	6	5	27	6	3	3.2	3.2	0.6	0.9
0821406501	6	10	32	6	3	3.2	3.2	0.6	0.9
0821406502	6	15	32	6	3	3.2	3.2	0.6	0.9
0821406503	6	20	37	6	3	3.2	3.2	0.6	0.9
0821406504	6	25	42	6	3	3.2	3.2	0.6	0.9
0821406505	6	30	47	6	3	3.2	3.2	0.6	0.9
0821406506	10	5	31	6.8	2.3	2.4	2.4	0.6	0.8
0821406507	10	10	36	6.8	2.3	2.4	2.4	0.6	0.8
0821406508	10	15	41	6.8	2.3	2.4	2.4	0.6	0.8
0821406509	10	20	41	6.8	3.2	3.3	3.3	0.7	1.2
0821406510	10	25	48	6.8	3.2	3.3	3.3	0.7	1.2
0821406511	10	30	53	6.8	3.2	3.3	3.3	0.7	1.2
0821406512	16	5	40	7.5	6.8	6.9	6.9	1.7	2.1
0821406513	16	10	40	7.5	6.8	6.9	6.9	1.7	2.1
0821406514	16	15	50	7.5	6.8	6.9	6.9	1.7	2.1
0821406515	16	20	50	7.5	6.8	6.9	6.9	1.7	2.1
0821406516	16	25	55	7.5	10	12.3	12.3	1.9	2.7
0821406517	16	30	60	7.5	10	12.3	12.3	1.9	2.7

Mini slide, Series MSN

0821406514

Series MSN

2024-08-21

Part No.	Mz Dynamic moment M [Nm]
0821406500	0.9
0821406501	0.9
0821406502	0.9
0821406503	0.9
0821406504	0.9
0821406505	0.9
0821406506	0.8
0821406507	0.8
0821406508	0.8
0821406509	1.2
0821406510	1.2
0821406511	1.2
0821406512	2.1
0821406513	2.1
0821406514	2.1
0821406515	2.1
0821406516	2.7
0821406517	2.7

Mini slide, Series MSN

0821406514

Series MSN

2024-08-21

Overview drawing

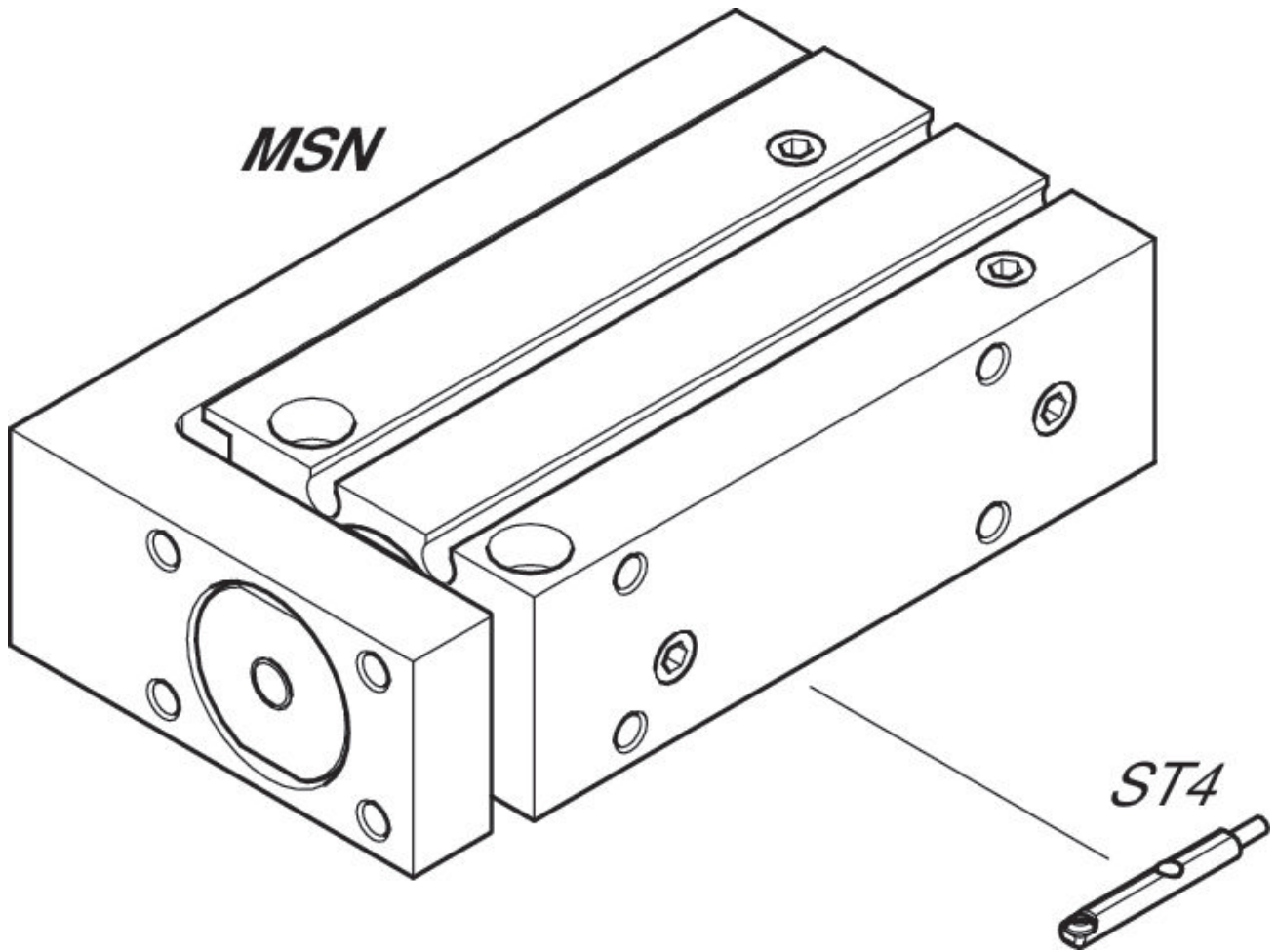

NOTE: This overview drawing is only for orientation to indicate where the various accessory parts can be fastened to the cylinder. The illustration has been simplified for this purpose. It is thus not possible to derive the dimensions from this overview.