

- Ø 32 mm ... 320 mm

AVENTICS Modular scraper systems and front lube unit

The AVENTICS Modular scraper system and front lube unit offer more flexibility by implementing a different scraper model with the same cylinder if yours needs changing. They are available separately as spare parts with fully installed seals and bushings and can be exchanged at any time, quickly and easily, without removing the cylinder.



Technical data

Industry

Industrial

For series

PRA
TRB
CCL-IS

Scraper

Heat-Resistant Metal Scraper

Application area

Chemical industry
Sugar production
Steel construction
Automotive industry
Woodworking industry

Piston Ø

50 mm
63 mm

Min. working pressure

1.5 bar

Max. working pressure

10 bar

Min. ambient temperature

-10 °C

Max. ambient temperature

150 °C

Medium

Compressed air

Min. oil content of compressed air

0 mg/m³

Max. oil content of compressed air

5 mg/m³

Modular scraper system

0496401506

Series MS

2023-12-20

Material

Housing material

Aluminum

Surface

anodized

Piston rod seal

Fluorocaoutchouc

Scraper

Brass

Part No.

0496401506

Dimensions

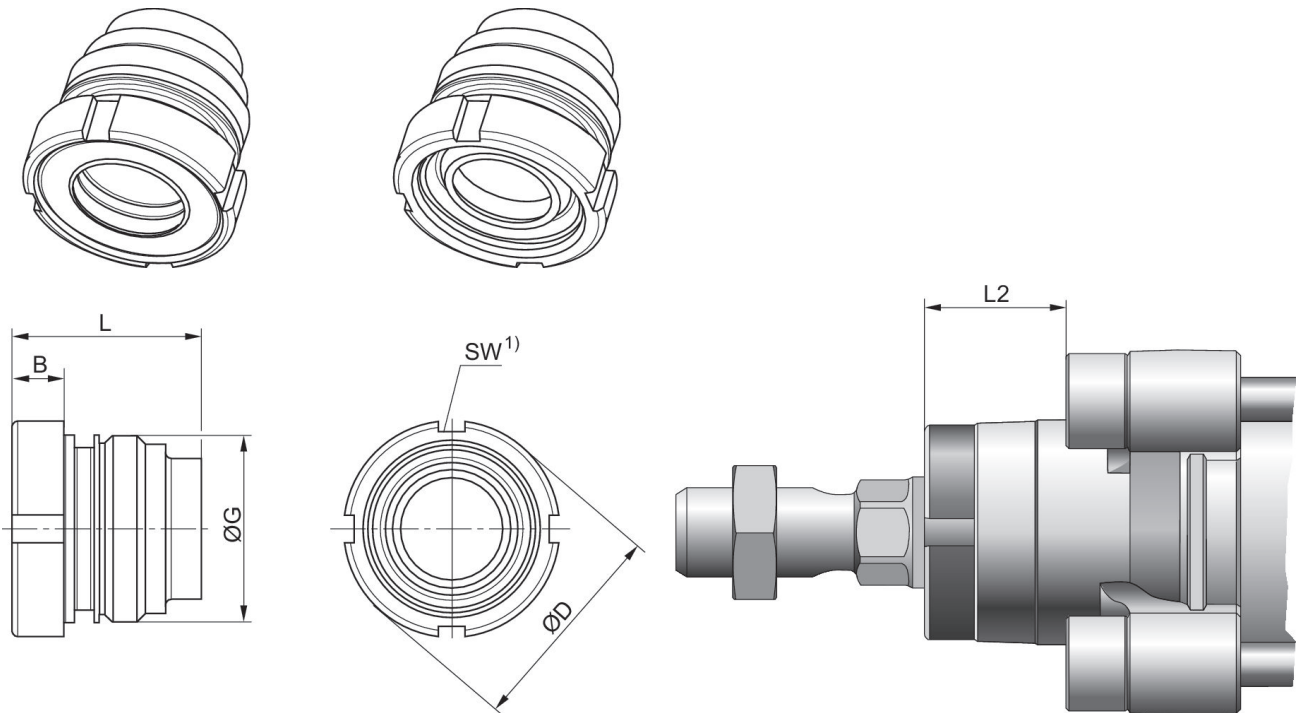

1) Can be mounted with hook wrench in accordance with DIN 1810 A

Piston Ø	B	ØD	G	L	L2	SW
50, 63	9	38.5	M33x2	33.5	25	40-42
80, 100	10	44	M40x2	44	33	45-50
125	12	57	M50x2	56	45	58-62