

- Ø 32 mm ... 320 mm

AVENTICS Modular scraper systems and front lube unit

The AVENTICS Modular scraper system and front lube unit offer more flexibility by implementing a different scraper model with the same cylinder if yours needs changing. They are available separately as spare parts with fully installed seals and bushings and can be exchanged at any time, quickly and easily, without removing the cylinder.

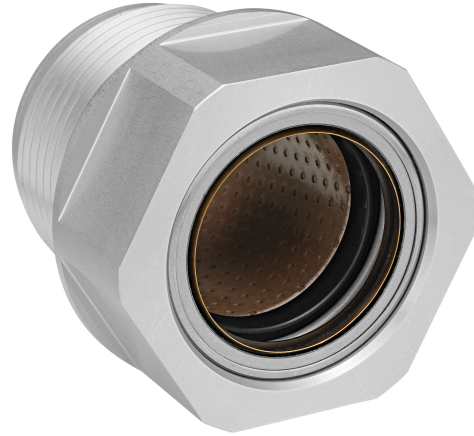

Technical data

Industry	Industrial
For series	ITS
Scraper	Metal Scraper
Application area	Chemical industry Sugar production Steel construction Automotive industry Woodworking industry
Piston Ø	320 mm
Min. working pressure	1.5 bar
Max. working pressure	10 bar
Min. ambient temperature	-40 °C
Max. ambient temperature	80 °C
Medium	Compressed air
Min. oil content of compressed air	0 mg/m ³
Max. oil content of compressed air	5 mg/m ³

Material

Housing material	Aluminum
Surface	anodized

Modular scraper system

R412018758

Series MS

2023-12-20

Piston rod seal

Polyurethane

Scraper

Brass

Part No.

R412018758

Modular scraper system

R412018758

Series MS

2023-12-20

Dimensions

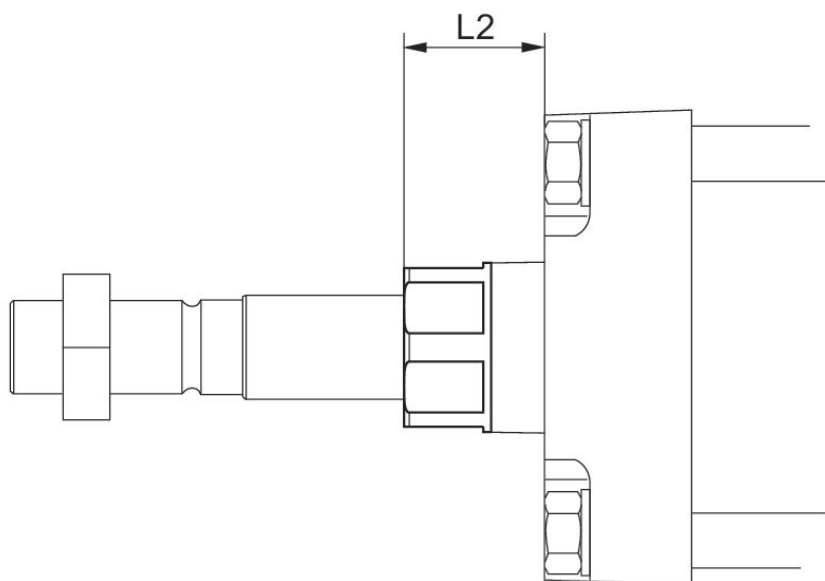
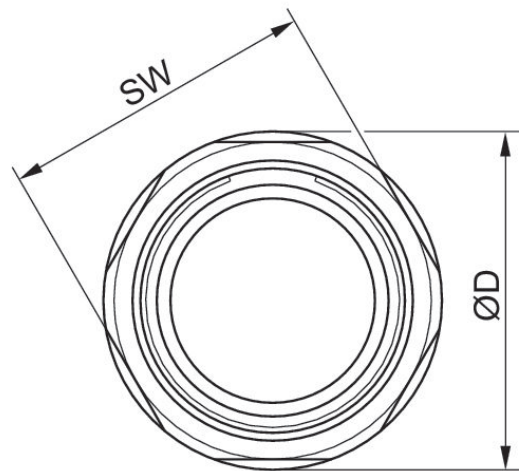
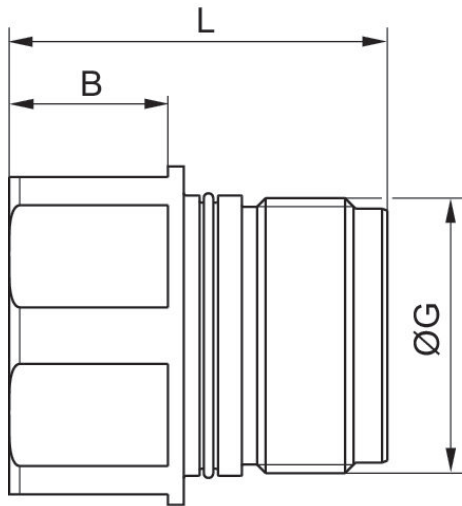
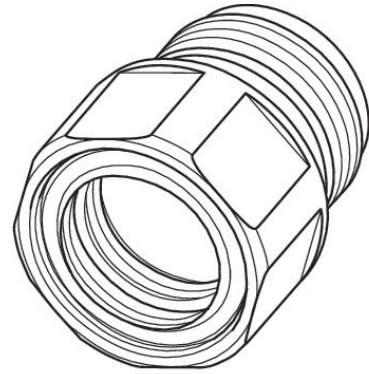
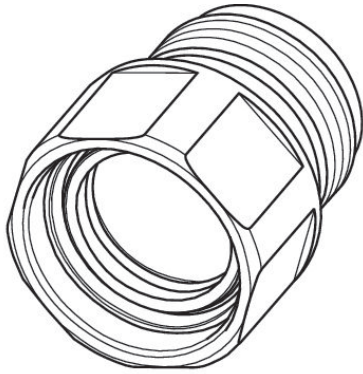

Modular scraper system

R412018758

Series MS

2023-12-20

Ø	B	ØD	G	L	L2	SW
160, 200	30	64	M52x3	71.5	56	60
250	31.5	88	M70x4	85.5	67	80
320	37	108	M85x4	97	76	95