

# Pressure regulator, Series MU1-RGS

0821302429

General series information  
AVENTICS Series MU1 Air Preparation Units

- The AVENTICS Series MU1 components are ideal for applications in harsh environments. They offer large thread connections to guarantee a high compressed air flow rate and provide reliable filtration, regulation and lubrication.

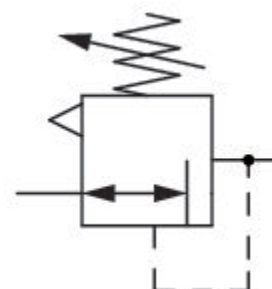

## Technical data

Industry	Industrial
Function	Standard pressure regulator
Parts	Pressure regulator
Pressure gauge	without pressure gauge
Mounting orientation	Any
Regulator type	Diaphragm-type pressure regulator
Port	G 1/4
Nominal flow Qn	450 l/min
Regulation range min.	0.1 bar
Regulation range max.	3.5 bar
Working pressure min.	0.5 bar
Working pressure max	25 bar

Min. ambient temperature	-10 °C
Max. ambient temperature	60 °C
Activation	Mechanical
Regulator function	with relieving air exhaust
Pressure supply	single
Medium	Compressed air Neutral gases
Weight	0.12 kg

## Material

Housing material	Die cast zinc
Seal material	Acrylonitrile butadiene rubber
Part No.	0821302429

## Technical information

The pressure dew point must be at least 15 °C less than ambient and medium temperature and may not exceed 3 °C.

Nominal flow  $Q_n$  with secondary pressure  $p_2 = 6$  bar at  $\Delta p = 1$  bar

Mounting with mounting bracket 1821331013

## Dimensions

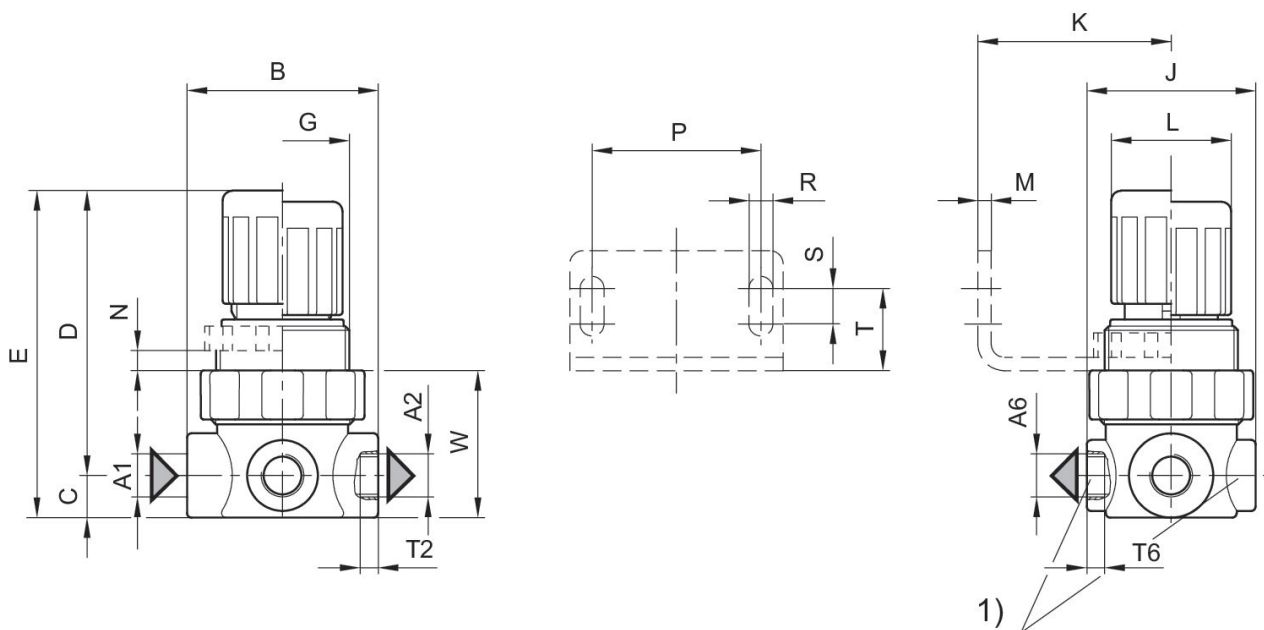

1) Pressure gauge connection

	A1	A2	A6	B	C	D	E	G	J
0821302425	G 1/8	G 1/8	G 1/8	43	9.5	61	70.5	M30x1,5	38
0821302426	G 1/8	G 1/8	G 1/8	43	9.5	61	70.5	M30x1,5	38
0821302427	G 1/8	G 1/8	G 1/8	43	9.5	61	70.5	M30x1,5	38
0821302429	G 1/4	G 1/4	G 1/8	43	9.5	61	70.5	M30x1,5	38
0821302448	G 1/4	G 1/4	G 1/8	43	9.5	61	70.5	M30x1,5	38
0821302449	G 1/4	G 1/4	G 1/8	43	9.5	61	70.5	M30x1,5	38

	K	L	M	N	P	R	S	T	T2
0821302425	40	27	3	5	38	5.4	8	18.5	8
0821302426	40	27	3	5	38	5.4	8	18.5	8
0821302427	40	27	3	5	38	5.4	8	18.5	8
0821302429	40	27	3	5	38	5.4	8	18.5	8
0821302448	40	27	3	5	38	5.4	8	18.5	8
0821302449	40	27	3	5	38	5.4	8	18.5	8

	T6	W
0821302425	8	33
0821302426	8	33
0821302427	8	33
0821302429	8	33
0821302448	8	33
0821302449	8	33

### Pressure characteristics curve

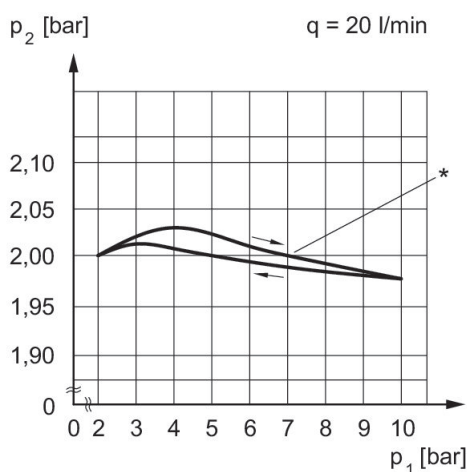

### Flow rate characteristic, $p_2 = 0,05 - 7$ bar

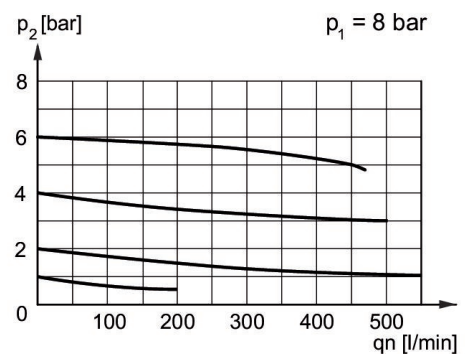

$p_1$  = Working pressure  $p_2$  = Secondary pressure  $q_n$  = Nominal flow

$p_1$  = working pressure  $p_2$  = secondary pressure  $q$  = flow rate  
\* starting point

### Exhaust

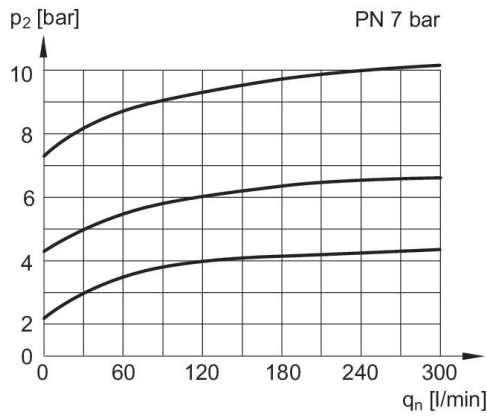

p2 = secondary pressure qn = nominal flow

### Exhaust

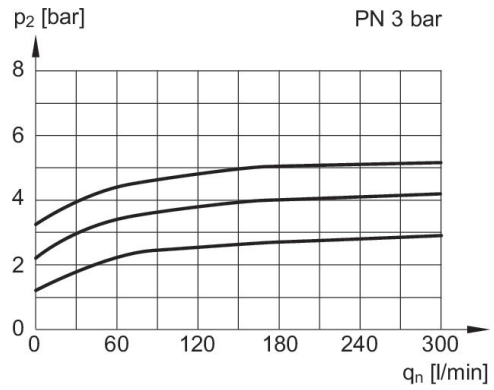

p2 = secondary pressure qn = nominal flow

### Exhaust

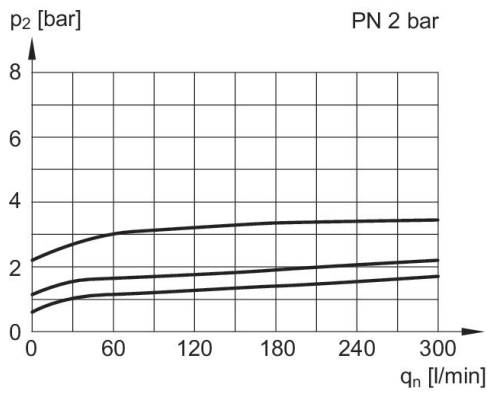

p2 = secondary pressure qn = nominal flow