

Pressure regulator, Series MU1-RGS

0821302449

General series information
AVENTICS Series MU1 Air Preparation Units

- The AVENTICS Series MU1 components are ideal for applications in harsh environments. They offer large thread connections to guarantee a high compressed air flow rate and provide reliable filtration, regulation and lubrication.

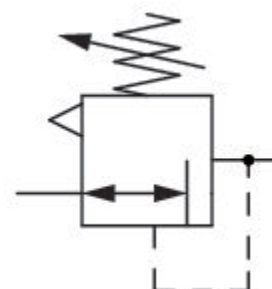

Technical data

Industry	Industrial
Function	Standard pressure regulator
Parts	Pressure regulator
Pressure gauge	without pressure gauge
Mounting orientation	Any
Regulator type	Diaphragm-type pressure regulator
Port	G 1/4
Nominal flow Qn	450 l/min
Regulation range min.	0.4 bar
Regulation range max.	10 bar
Working pressure min.	0.5 bar
Working pressure max.	25 bar

Min. ambient temperature	-10 °C
Max. ambient temperature	60 °C
Activation	Mechanical
Regulator function	with relieving air exhaust
Pressure supply	single
Medium	Compressed air Neutral gases
Weight	0.12 kg

Material

Housing material	Die cast zinc
Seal material	Acrylonitrile butadiene rubber
Part No.	0821302449

Technical information

The pressure dew point must be at least 15 °C less than ambient and medium temperature and may not exceed 3 °C.

Nominal flow Q_n with secondary pressure $p_2 = 6$ bar at $\Delta p = 1$ bar

Mounting with mounting bracket 1821331013

Dimensions

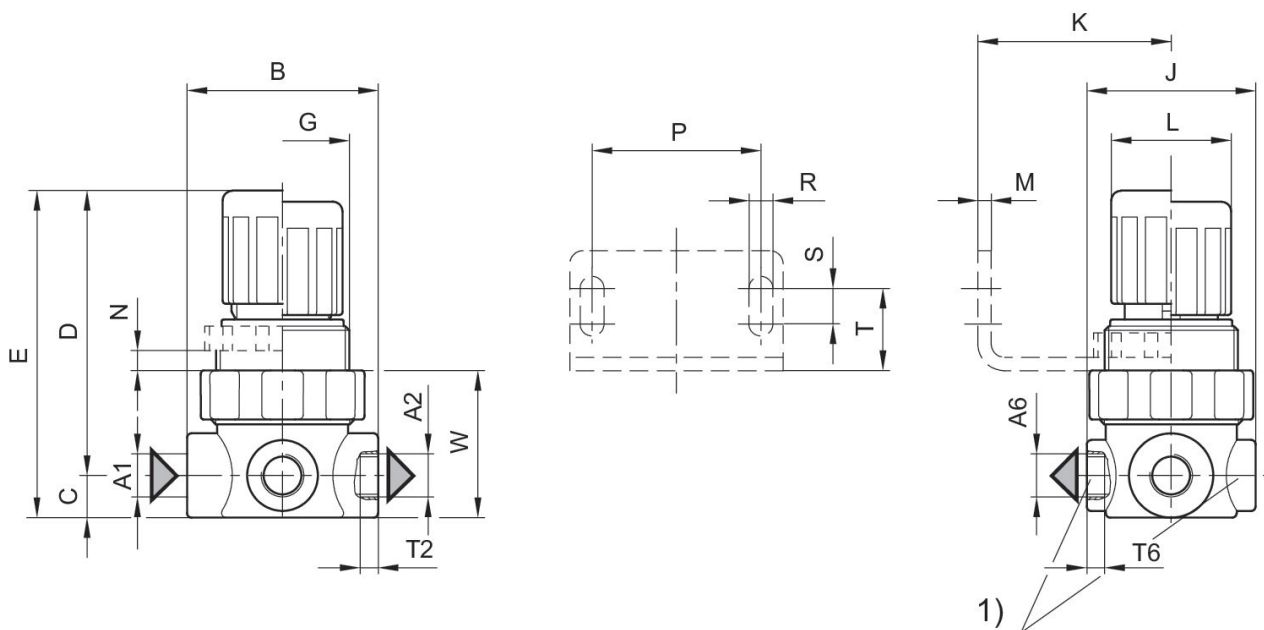

1) Pressure gauge connection

	A1	A2	A6	B	C	D	E	G	J
0821302425	G 1/8	G 1/8	G 1/8	43	9.5	61	70.5	M30x1,5	38
0821302426	G 1/8	G 1/8	G 1/8	43	9.5	61	70.5	M30x1,5	38
0821302427	G 1/8	G 1/8	G 1/8	43	9.5	61	70.5	M30x1,5	38
0821302429	G 1/4	G 1/4	G 1/8	43	9.5	61	70.5	M30x1,5	38
0821302448	G 1/4	G 1/4	G 1/8	43	9.5	61	70.5	M30x1,5	38
0821302449	G 1/4	G 1/4	G 1/8	43	9.5	61	70.5	M30x1,5	38

	K	L	M	N	P	R	S	T	T2
0821302425	40	27	3	5	38	5.4	8	18.5	8
0821302426	40	27	3	5	38	5.4	8	18.5	8
0821302427	40	27	3	5	38	5.4	8	18.5	8
0821302429	40	27	3	5	38	5.4	8	18.5	8
0821302448	40	27	3	5	38	5.4	8	18.5	8
0821302449	40	27	3	5	38	5.4	8	18.5	8

	T6	W
0821302425	8	33
0821302426	8	33
0821302427	8	33
0821302429	8	33
0821302448	8	33
0821302449	8	33

Pressure characteristics curve

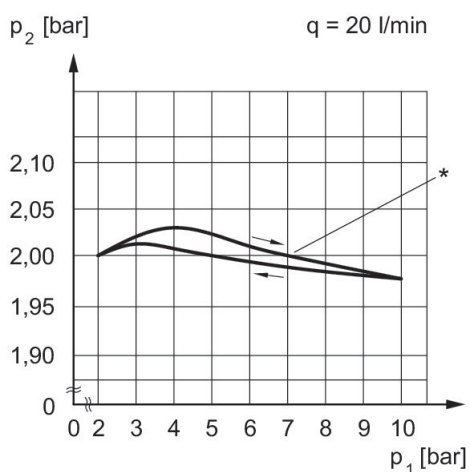

Flow rate characteristic, $p_2 = 0,05 - 7$ bar

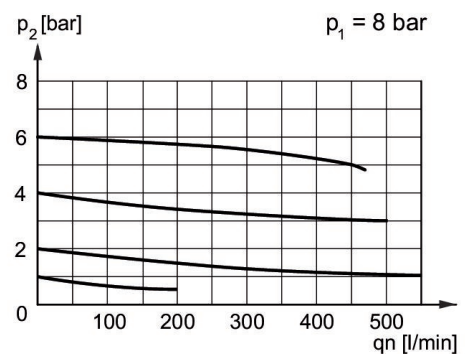

p_1 = Working pressure p_2 = Secondary pressure q_n = Nominal flow

p_1 = working pressure p_2 = secondary pressure q = flow rate
* starting point

Exhaust

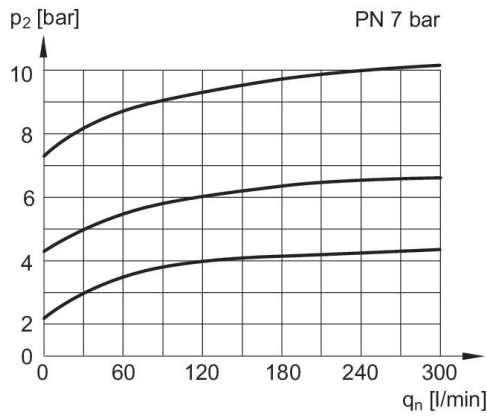

p2 = secondary pressure qn = nominal flow

Exhaust

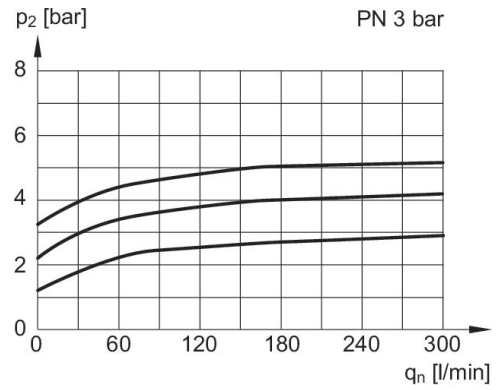

p2 = secondary pressure qn = nominal flow

Exhaust

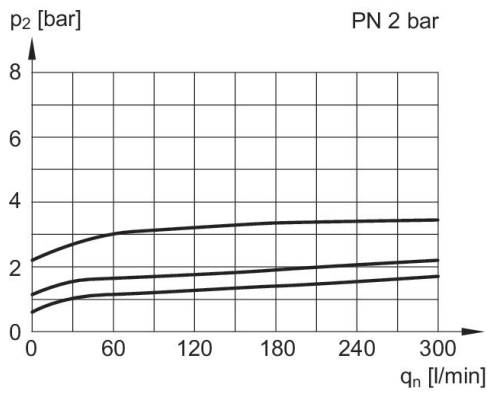

p2 = secondary pressure qn = nominal flow