

AVENTICS Series NL1 Air Preparation Units

The AVENTICS Series NL maintenance units are suitable for all areas: as individual components or as assembled maintenance units, for centralized or decentralized compressed air preparation, in compact or powerful versions, for use in high or low temperatures. This line offers a complete, customizable compressed air preparation technology. It includes an option to combine every component in the Series to achieve the desired function, making it possible to adjust the components precisely to the application requirements.

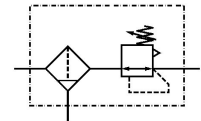

Technical data

Industry	Industrial
Parts	Filter pressure regulator
Reservoir	reservoir, polycarbonate, without protective guard
Port	G 1/8
Nominal flow Qn	1350 l/min
Filter porosity	5 µm
Condensate drain	semi-automatic, open without pressure
Pressure gauge	without pressure gauge
Min. working pressure	1.5 bar
Max. working pressure	16 bar
Min. ambient temperature	-10 °C
Max. ambient temperature	60 °C
Min. regulation range	0.5 bar
Max. regulation range	10 bar
Lock type	not lockable
Type	1-part
Type	Can be assembled into blocks
Pressure supply	single
Mounting orientation	vertical

Filter pressure regulator, Series NL1-FRE

NL1

0821300753

2024-04-23

Regulator type	Diaphragm-type pressure regulator
Regulator function	with relieving air exhaust
Filter element	exchangeable
Filter reservoir volume	16 cm ³
Max. achievable compressed air class acc. to ISO 8573-1:2010	6 : 7 : -
Medium	Compressed air Neutral gases
Weight	0.334 kg

Material

Housing material	Die cast zinc
Seal material	Acrylonitrile butadiene rubber
Material front plate	Acrylonitrile butadiene styrene
Material threaded bushing	Die cast zinc
Material reservoir	Polycarbonate
Material filter insert	Polyethylene
Part No.	0821300753

Technical information

The pressure dew point must be at least 15 °C less than ambient and medium temperature and may not exceed 3 °C.

Nominal flow Q_n with secondary pressure $p_2 = 6$ bar at $\Delta p = 1$ bar

A change in the flow direction (from air supply on the left to air supply on the right) occurs by rotating installation by 180° about the vertical axis. Please see the operating instructions for further details.

Also suitable for separation of fluid oil or water due to the design.

The rear pressure gauge connection on the pressure regulator is closed with a blanking plug, the front connection is open. Depending on the customer application, a second blanking plug may be necessary. Please order separately (see accessories).

Order pressure gauge separately

Metal protective guard can be retrofitted for all polycarbonate reservoirs

Filter pressure regulator, Series NL1-FRE

0821300753

NL1

2024-04-23

Dimensions

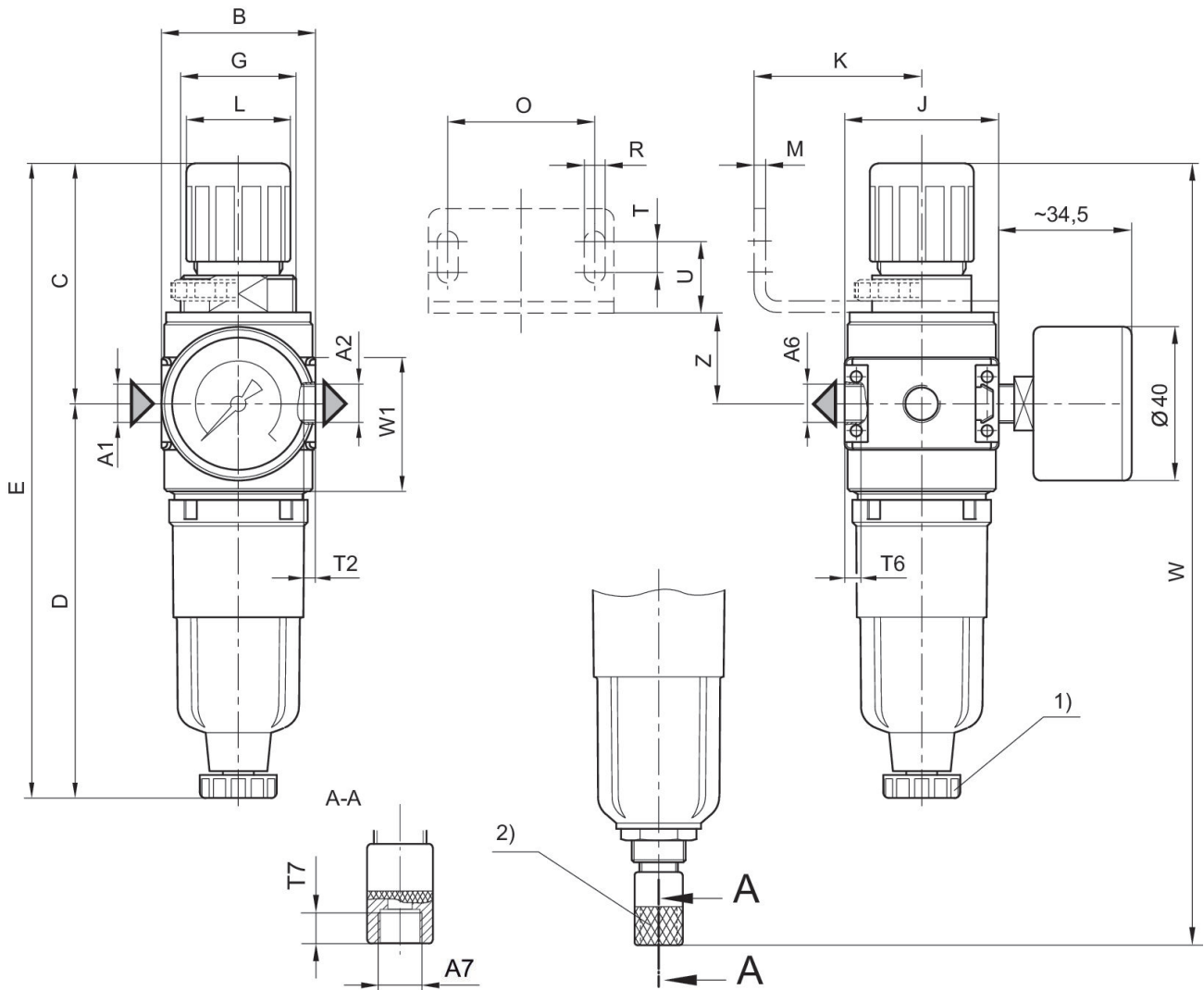

A1 = input A2 = output

A4 = output A6 = output

1) Semi-automatic condensate drain 2) fully automatic condensate drain

Dimensions in mm

Part No.	A1	A2	A3	A6	A7	B	C	D	E
0821300750	G 1/8	G 1/8	G 1/8	G 1/8	G 1/8	40	62.5	102.5	165
0821300751	G 1/8	G 1/8	G 1/8	G 1/8	G 1/8	40	62.5	102.5	165
0821300752	G 1/8	G 1/8	G 1/8	G 1/8	G 1/8	40	62.5	102.5	165
0821300753	G 1/8	G 1/8	G 1/8	G 1/8	G 1/8	40	62.5	102.5	165
0821300754	G 1/8	G 1/8	G 1/8	G 1/8	G 1/8	40	62.5	102.5	165
0821300755	G 1/8	G 1/8	G 1/8	G 1/8	G 1/8	40	62.5	102.5	165
0821300756	G 1/4	G 1/4	G 1/8	G 1/8	G 1/8	40	62.5	102.5	165
0821300757	G 1/4	G 1/4	G 1/8	G 1/8	G 1/8	40	62.5	102.5	165
0821300758	G 1/4	G 1/4	G 1/8	G 1/8	G 1/8	40	62.5	102.5	165

Filter pressure regulator, Series NL1-FRE

NL1

0821300753

2024-04-23

Part No.	A1	A2	A3	A6	A7	B	C	D	E
0821300759	G 1/4	G 1/4	G 1/8	G 1/8	G 1/8	40	62.5	102.5	165
0821300760	G 1/4	G 1/4	G 1/8	G 1/8	G 1/8	40	62.5	102.5	165
0821300761	G 1/4	G 1/4	G 1/8	G 1/8	G 1/8	40	62.5	102.5	165

Part No.	G	J	K	L	M	O	R	T	T2
0821300750	M30x1,5	40	43.5	27	3	38	5.4	8	8
0821300751	M30x1,5	40	43.5	27	3	38	5.4	8	8
0821300752	M30x1,5	40	43.5	27	3	38	5.4	8	8
0821300753	M30x1,5	40	43.5	27	3	38	5.4	8	8
0821300754	M30x1,5	40	43.5	27	3	38	5.4	8	8
0821300755	M30x1,5	40	43.5	27	3	38	5.4	8	8
0821300756	M30x1,5	40	43.5	27	3	38	5.4	8	8
0821300757	M30x1,5	40	43.5	27	3	38	5.4	8	8
0821300758	M30x1,5	40	43.5	27	3	38	5.4	8	8
0821300759	M30x1,5	40	43.5	27	3	38	5.4	8	8
0821300760	M30x1,5	40	43.5	27	3	38	5.4	8	8
0821300761	M30x1,5	40	43.5	27	3	38	5.4	8	8

Part No.	T6	T7	U	W	W1	Z
0821300750	6	8.5	18.5	203	44	24.5
0821300751	6	8.5	18.5	203	44	24.5
0821300752	6	8.5	18.5	203	44	24.5
0821300753	6	8.5	18.5	203	44	24.5
0821300754	6	8.5	18.5	203	44	24.5
0821300755	6	8.5	18.5	203	44	24.5
0821300756	6	8.5	18.5	203	44	24.5
0821300757	6	8.5	18.5	203	44	24.5
0821300758	6	8.5	18.5	203	44	24.5
0821300759	6	8.5	18.5	203	44	24.5
0821300760	6	8.5	18.5	203	44	24.5
0821300761	6	8.5	18.5	203	44	24.5

Flow rate characteristic, $p_2 = 0,05 - 7$ bar Pressure characteristics curve

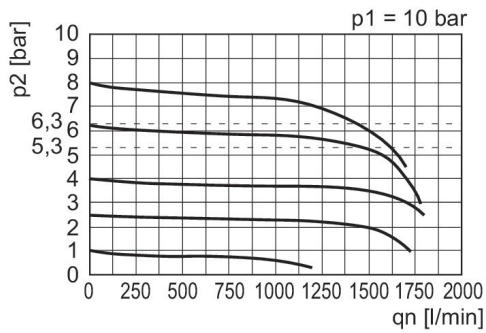

p_1 = Working pressure p_2 = Secondary pressure q_n = Nominal flow

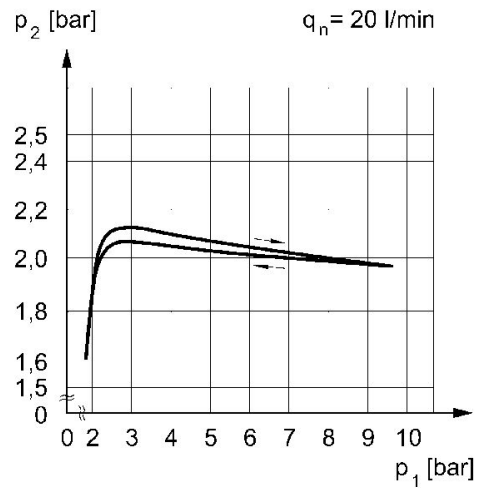

p_1 = Working pressure p_2 = Secondary pressure q_n = Nominal flow