

AVENTICS Series NL1 Air Preparation Units

The AVENTICS Series NL maintenance units are suitable for all areas: as individual components or as assembled maintenance units, for centralized or decentralized compressed air preparation, in compact or powerful versions, for use in high or low temperatures. This line offers a complete, customizable compressed air preparation technology. It includes an option to combine every component in the Series to achieve the desired function, making it possible to adjust the components precisely to the application requirements.

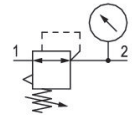

Technical data

Industry	Industrial
Function	Pressure regulator, high flow rate
Parts	Pressure regulator
Pressure gauge	pressure gauge in hand wheel
Mounting orientation	Any
Regulator type	Diaphragm-type pressure regulator
Port	G 1/4
Nominal flow Qn	1350 l/min
Min. regulation range	0.1 bar
Max. regulation range	3 bar
Min. working pressure	0.5 bar
Max. working pressure	16 bar
Min. ambient temperature	-10 °C
Max. ambient temperature	60 °C
Activation	Mechanical
Regulator function	with relieving air exhaust
Regulator type	Can be assembled into blocks
Pressure supply	single
Medium	Compressed air Neutral gases

Pressure regulator, Series NL1-RGS

Series NL1

0821300666

2024-04-23

Recommended pre-filtering	5 µm
Weight	0.35 kg

Material

Housing material	Die cast zinc
Seal material	Acrylonitrile butadiene rubber
Part No.	0821300666

Technical information

The pressure dew point must be at least 15 °C less than ambient and medium temperature and may not exceed 3 °C.

Nominal flow Q_n with secondary pressure $p_2 = 6$ bar at $\Delta p = 1$ bar

A change in the flow direction (from air supply on the left to air supply on the right) occurs by rotating installation by 180° about the vertical axis. Please see the operating instructions for further details.

Relieving exhaust (≤ 0.3 bar over set pressure)

With rear exhaust (>3 bar)

Panel nut included in scope of delivery

Dimensions

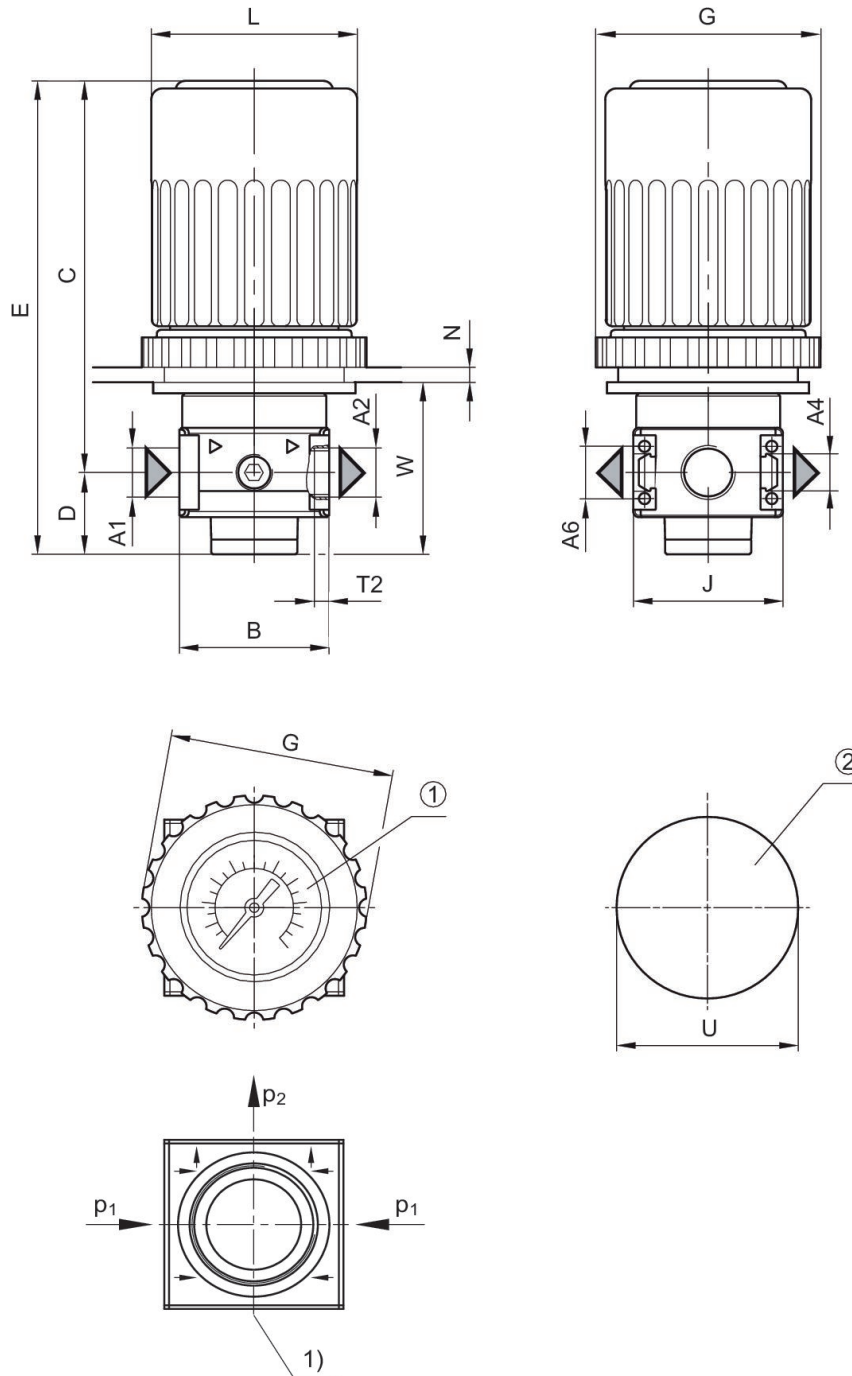

- A1 = input
- A2 = output
- A4 = output
- A6 = output
- 1) Pressure gauge \varnothing 40
- 2) Opening for control panel assembly

Dimensions in mm

Part No.	A1	A2	A4	A6	B	C	D	E	G
0821300663	G 1/8	G 1/8	G 1/8	G 1/8	40	102	22	124	60
0821300664	G 1/8	G 1/8	G 1/8	G 1/8	40	102	22	124	60
0821300665	G 1/8	G 1/8	G 1/8	G 1/8	40	102	22	124	60
0821300666	G 1/4	G 1/4	G 1/8	G 1/8	40	102	22	124	60
0821300667	G 1/4	G 1/4	G 1/8	G 1/8	40	102	22	124	60
0821300668	G 1/4	G 1/4	G 1/8	G 1/8	40	102	22	124	60

Part No.	J	L	N	T2	U	W
0821300663	40	54	4	8	48.5	43
0821300664	40	54	4	8	48.5	43
0821300665	40	54	4	8	48.5	43
0821300666	40	54	4	8	48.5	43
0821300667	40	54	4	8	48.5	43
0821300668	40	54	4	8	48.5	43

Pressure characteristics curve

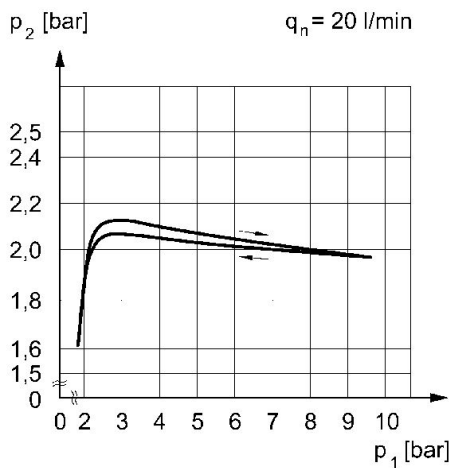

p1 = Working pressure
 p2 = Secondary pressure
 qn = Nominal flow

Flow rate characteristic (setting range p2: 0.5 - 10 bar)

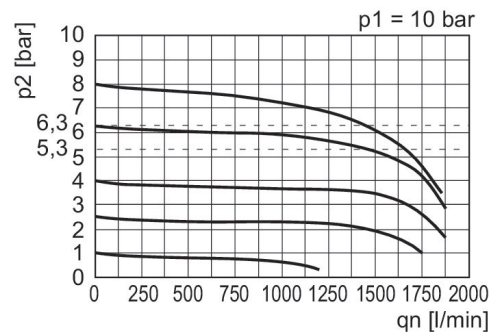

p1 = Working pressure
 p2 = Secondary pressure
 qn = Nominal flow