

## AVENTICS Series NL2 Air Preparation Units

The AVENTICS Series NL maintenance units are suitable for all areas: as individual components or as assembled maintenance units, for centralized or decentralized compressed air preparation, in compact or powerful versions, for use in high or low temperatures. This line offers a complete, customizable compressed air preparation technology. It includes an option to combine every component in the Series to achieve the desired function, making it possible to adjust the components precisely to the application requirements.

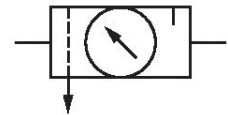

### Technical data

Industry	Industrial
Parts	Air preparation units
Components	Filter pressure regulator Lubricator
Reservoir	reservoir, polycarbonate, with metal protective guard
Port	G 3/8
Nominal flow Qn	1100 l/min
Filter porosity	5 µm
Condensate drain	semi-automatic, open without pressure
Pressure gauge	with pressure gauge
Min. working pressure	2 bar
Max. working pressure	16 bar
Min. ambient temperature	-10 °C
Max. ambient temperature	60 °C
Min. regulation range	0.5 bar
Max. regulation range	10 bar
Type	2-part
Type	Can be assembled into blocks
Pressure supply	single

Mounting orientation	vertical
Regulator type	Diaphragm-type pressure regulator
Regulator function	with relieving air exhaust
Filter element	exchangeable
Filter reservoir volume	25 cm <sup>3</sup>
Max. achievable compressed air class acc. to ISO 8573-1:2010	6 : 7 : -
Lubricator reservoir volume	50 cm <sup>3</sup>
Type of filling	Manual oil filling
Oil dosing at 1000 l/min	1-2 drops
Medium	Compressed air Neutral gases
Weight	0.932 kg

## Material

Housing material	Die cast zinc
Seal material	Acrylonitrile butadiene rubber
Material front plate	Acrylonitrile butadiene styrene
Material reservoir	Polycarbonate
Material protective guard	Steel, chrome-plated
Material filter insert	Polyethylene
Part No.	0821300431

## Technical information

The pressure dew point must be at least 15 °C less than ambient and medium temperature and may not exceed 3 °C.

Nominal flow  $Q_n$  with secondary pressure  $p_2 = 6$  bar at  $\Delta p = 1$  bar

Note: Polycarbonate reservoirs are susceptible to solvents, supplementary information can be found at "Customer information".

A change in the flow direction (from air supply on the left to air supply on the right) occurs by rotating installation by 180° about the vertical axis. Please see the operating instructions for further details.

Also suitable for separation of fluid oil or water due to the design.

# Air preparation unit, 2-part, Series NL2-ACD

NL2

0821300431

2024-04-23

## Dimensions

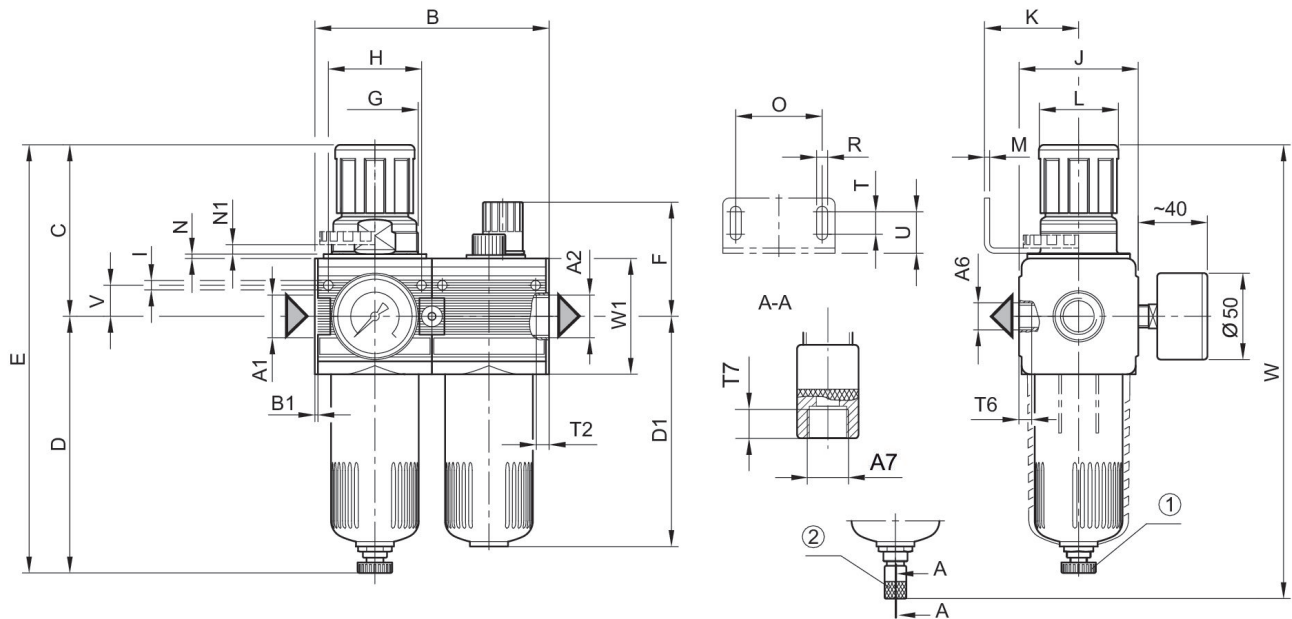

A1 = input A2 = output A6 = output

1) Semi-automatic condensate drain 2) fully automatic condensate drain  
 1) Semi-automatic condensate drain 2) fully automatic condensate drain

## Dimensions in mm

Part No.	A1	A2	A6	A7	B	B1	C	D	D1
0821300400	G 1/4	G 1/4	G 1/4	G 1/8	93	1.5	67.5	125	109
0821300403	G 1/4	G 1/4	G 1/4	G 1/8	93	1.5	67.5	125	109
0821300401	G 1/4	G 1/4	G 1/4	G 1/8	93	1.5	67.5	125	109
0821300404	G 1/4	G 1/4	G 1/4	G 1/8	93	1.5	67.5	125	109
0821300402	G 1/4	G 1/4	G 1/4	G 1/8	93	1.5	67.5	125	109
0821300405	G 1/4	G 1/4	G 1/4	G 1/8	93	1.5	67.5	125	109
0821300430	G 3/8	G 3/8	G 1/4	G 1/8	93	1.5	67.5	125	109
0821300433	G 3/8	G 3/8	G 1/4	G 1/8	93	1.5	67.5	125	109
0821300431	G 3/8	G 3/8	G 1/4	G 1/8	93	1.5	67.5	125	109
0821300434	G 3/8	G 3/8	G 1/4	G 1/8	93	1.5	67.5	125	109
0821300432	G 3/8	G 3/8	G 1/4	G 1/8	93	1.5	67.5	125	109
0821300435	G 3/8	G 3/8	G 1/4	G 1/8	93	1.5	67.5	125	109

Part No.	E	F	G	H	I	J	K	L	M
0821300400	192.5	58	M30x1,5	36	4.4	47	43.5	28	3
0821300403	192.5	58	M30x1,5	36	4.4	47	43.5	28	3
0821300401	192.5	58	M30x1,5	36	4.4	47	43.5	28	3
0821300404	192.5	58	M30x1,5	36	4.4	47	43.5	28	3
0821300402	192.5	58	M30x1,5	36	4.4	47	43.5	28	3
0821300405	192.5	58	M30x1,5	36	4.4	47	43.5	28	3
0821300430	192.5	58	M30x1,5	36	4.4	47	43.5	28	3

# Air preparation unit, 2-part, Series NL2-ACD

0821300431

NL2

2024-04-23

Part No.	E	F	G	H	I	J	K	L	M
0821300433	192.5	58	M30x1,5	36	4.4	47	43.5	28	3
0821300431	192.5	58	M30x1,5	36	4.4	47	43.5	28	3
0821300434	192.5	58	M30x1,5	36	4.4	47	43.5	28	3
0821300432	192.5	58	M30x1,5	36	4.4	47	43.5	28	3
0821300435	192.5	58	M30x1,5	36	4.4	47	43.5	28	3

Part No.	N	N1	O	R	T	T2	T6	T7	U
0821300400	3	3.5	38	5.4	8	9.5	7	8.5	18.5
0821300403	3	3.5	38	5.4	8	9.5	7	8.5	18.5
0821300401	3	3.5	38	5.4	8	9.5	7	8.5	18.5
0821300404	3	3.5	38	5.4	8	9.5	7	8.5	18.5
0821300402	3	3.5	38	5.4	8	9.5	7	8.5	18.5
0821300405	3	3.5	38	5.4	8	9.5	7	8.5	18.5
0821300430	3	3.5	38	5.4	8	9.5	7	8.5	18.5
0821300433	3	3.5	38	5.4	8	9.5	7	8.5	18.5
0821300431	3	3.5	38	5.4	8	9.5	7	8.5	18.5
0821300434	3	3.5	38	5.4	8	9.5	7	8.5	18.5
0821300432	3	3.5	38	5.4	8	9.5	7	8.5	18.5
0821300435	3	3.5	38	5.4	8	9.5	7	8.5	18.5

Part No.	V	W	W1
0821300400	12.3	205.5	52
0821300403	12.3	205.5	52
0821300401	12.3	205.5	52
0821300404	12.3	205.5	52
0821300402	12.3	205.5	52
0821300405	12.3	205.5	52
0821300430	12.3	205.5	52
0821300433	12.3	205.5	52
0821300431	12.3	205.5	52
0821300434	12.3	205.5	52
0821300432	12.3	205.5	52
0821300435	12.3	205.5	52

Flow rate characteristic,  $p_2 = 0,05 - 7$  bar

minimum flow rate curve (flow rate necessary for the correct functioning of the lubricator)

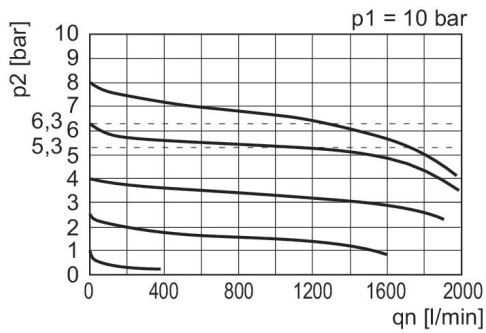

$p_1$  = Working pressure  
 $p_2$  = Secondary pressure  
 $q_n$  = Nominal flow

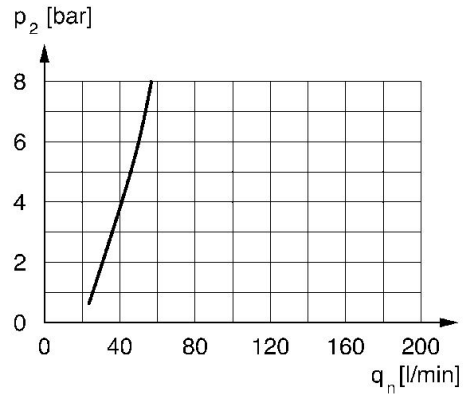

$p_1$  = Working pressure  
 $p_2$  = Secondary pressure  
 $q_n$  = Nominal flow