

AVENTICS Series NL2 Air Preparation Units

The AVENTICS Series NL maintenance units are suitable for all areas: as individual components or as assembled maintenance units, for centralized or decentralized compressed air preparation, in compact or powerful versions, for use in high or low temperatures. This line offers a complete, customizable compressed air preparation technology. It includes an option to combine every component in the Series to achieve the desired function, making it possible to adjust the components precisely to the application requirements.

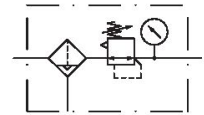

Technical data

Industry	Industrial
Parts	Filter pressure regulator
Reservoir	reservoir, polycarbonate, without protective guard
Port	G 3/8
Nominal flow Qn	1650 l/min
Filter porosity	5 µm
Condensate drain	semi-automatic, open without pressure
Pressure gauge	with pressure gauge
Min. working pressure	2 bar
Max. working pressure	16 bar
Min. ambient temperature	-10 °C
Max. ambient temperature	60 °C
Min. regulation range	0.5 bar
Max. regulation range	10 bar
Type	1-part
Type	Can be assembled into blocks
Pressure supply	single
Mounting orientation	vertical
Regulator type	Diaphragm-type pressure regulator

Filter pressure regulator, Series NL2-FRE

NL2

0821300330

2024-04-23

Regulator function	with relieving air exhaust
Filter element	exchangeable
Filter reservoir volume	25 cm ³
Max. achievable compressed air class acc. to ISO 8573-1:2010	6 : 7 : -
Medium	Compressed air Neutral gases
Weight	0.542 kg

Material

Housing material	Die cast zinc
Seal material	Acrylonitrile butadiene rubber
Material front plate	Acrylonitrile butadiene styrene
Material reservoir	Polycarbonate
Material filter insert	Polyethylene
Part No.	0821300330

Technical information

The pressure dew point must be at least 15 °C less than ambient and medium temperature and may not exceed 3 °C.

Nominal flow Q_n with secondary pressure $p_2 = 6$ bar at $\Delta p = 1$ bar

Note: Polycarbonate reservoirs are susceptible to solvents, supplementary information can be found at "Customer information".

A change in the flow direction (from air supply on the left to air supply on the right) occurs by rotating installation by 180° about the vertical axis. Please see the operating instructions for further details.

Also suitable for separation of fluid oil or water due to the design.

The rear pressure gauge connection on the pressure regulator is closed with a blanking plug, the front connection is open. Depending on the customer application, a second blanking plug may be necessary. Please order separately (see accessories).

Filter pressure regulator, Series NL2-FRE

NL2

0821300330

2024-04-23

Dimensions

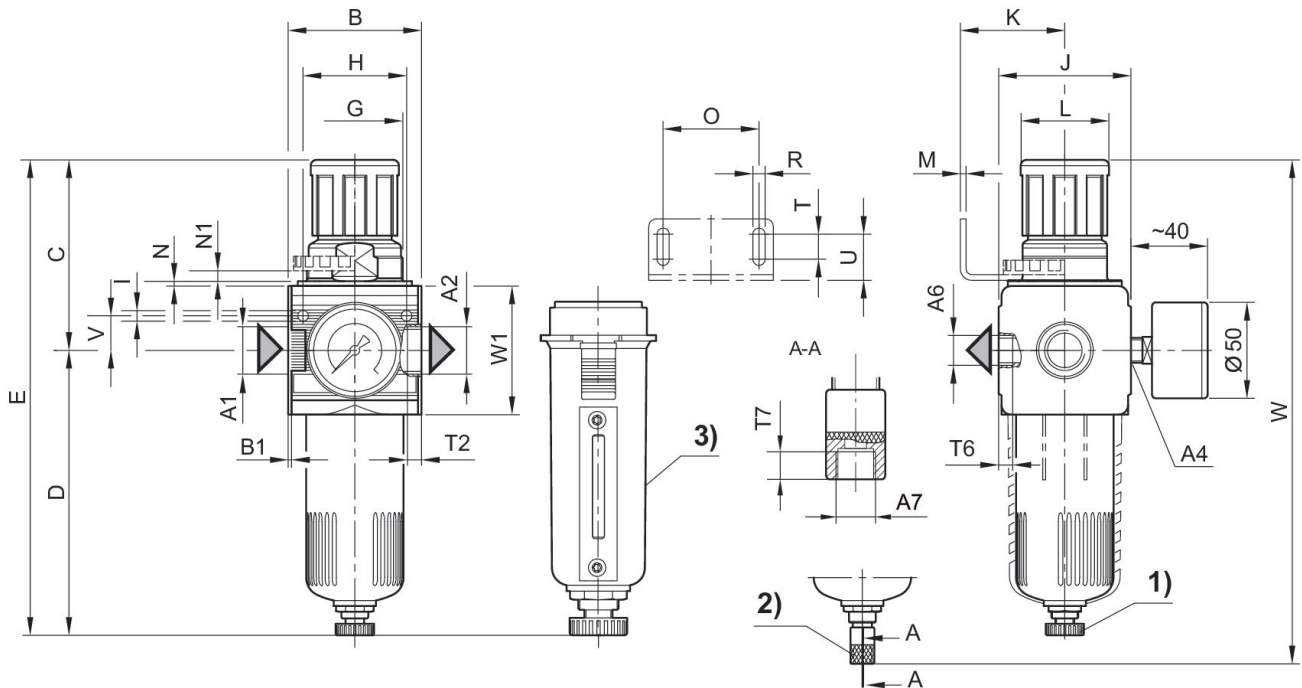

A1 = input A2 = output A6 = output

A7 = condensate drain

1) Semi-automatic condensate drain 2) fully automatic condensate drain

3) Metal reservoir

Dimensions in mm

Part No.	A1	A2	A4	A6	A7	B	B1	C	D
0821300300	G 1/4	G 1/4	G 1/4	G 1/4	G 1/8	48	1.5	71	124.5
0821300301	G 1/4	G 1/4	G 1/4	G 1/4	G 1/8	48	1.5	71	124.5
0821300302	G 1/4	G 1/4	G 1/4	G 1/4	G 1/8	48	1.5	71	124.5
0821300303	G 1/4	G 1/4	G 1/4	G 1/4	G 1/8	48	1.5	71	124.5
0821300304	G 1/4	G 1/4	G 1/4	G 1/4	G 1/8	48	1.5	71	124.5
0821300307	G 1/4	G 1/4	G 1/4	G 1/4	G 1/8	48	1.5	71	124.5
0821300308	G 1/4	G 1/4	G 1/4	G 1/4	G 1/8	48	1.5	71	124.5
0821300305	G 1/4	G 1/4	G 1/4	G 1/4	G 1/8	48	1.5	71	124.5
0821300330	G 3/8	G 3/8	G 1/4	G 1/4	G 1/8	48	1.5	71	124.5
0821300331	G 3/8	G 3/8	G 1/4	G 1/4	G 1/8	48	1.5	71	124.5
0821300332	G 3/8	G 3/8	G 1/4	G 1/4	G 1/8	48	1.5	71	124.5
0821300333	G 3/8	G 3/8	G 1/4	G 1/4	G 1/8	48	1.5	71	124.5
0821300334	G 3/8	G 3/8	G 1/4	G 1/4	G 1/8	48	1.5	71	124.5
0821300335	G 3/8	G 3/8	G 1/4	G 1/4	G 1/8	48	1.5	71	124.5

Part No.	E	G	H	I	J	K	L	M	N
0821300300	191	M30x1,5	36	4.4	47	43.5	28	3	3.5
0821300301	191	M30x1,5	36	4.4	47	43.5	28	3	3.5
0821300302	191	M30x1,5	36	4.4	47	43.5	28	3	3.5

Filter pressure regulator, Series NL2-FRE

NL2

0821300330

2024-04-23

Part No.	E	G	H	I	J	K	L	M	N
0821300303	191	M30x1,5	36	4.4	47	43.5	28	3	3.5
0821300304	191	M30x1,5	36	4.4	47	43.5	28	3	3.5
0821300307	191	M30x1,5	36	4.4	47	43.5	28	3	3.5
0821300308	191	M30x1,5	36	4.4	47	43.5	28	3	3.5
0821300305	191	M30x1,5	36	4.4	47	43.5	28	3	3.5
0821300330	191	M30x1,5	36	4.4	47	43.5	28	3	3.5
0821300331	191	M30x1,5	36	4.4	47	43.5	28	3	3.5
0821300332	191	M30x1,5	36	4.4	47	43.5	28	3	3.5
0821300333	191	M30x1,5	36	4.4	47	43.5	28	3	3.5
0821300334	191	M30x1,5	36	4.4	47	43.5	28	3	3.5
0821300335	191	M30x1,5	36	4.4	47	43.5	28	3	3.5

Part No.	N1	O	R	T	T2	T6	T7	U	V
0821300300	3	38	5.4	8	9.5	7	8.5	18.5	12.3
0821300301	3	38	5.4	8	9.5	7	8.5	18.5	12.3
0821300302	3	38	5.4	8	9.5	7	8.5	18.5	12.3
0821300303	3	38	5.4	8	9.5	7	8.5	18.5	12.3
0821300304	3	38	5.4	8	9.5	7	8.5	18.5	12.3
0821300307	3	38	5.4	8	9.5	7	8.5	18.5	12.3
0821300308	3	38	5.4	8	9.5	7	8.5	18.5	12.3
0821300305	3	38	5.4	8	9.5	7	8.5	18.5	12.3
0821300330	3	38	5.4	8	9.5	7	8.5	18.5	12.3
0821300331	3	38	5.4	8	9.5	7	8.5	18.5	12.3
0821300332	3	38	5.4	8	9.5	7	8.5	18.5	12.3
0821300333	3	38	5.4	8	9.5	7	8.5	18.5	12.3
0821300334	3	38	5.4	8	9.5	7	8.5	18.5	12.3
0821300335	3	38	5.4	8	9.5	7	8.5	18.5	12.3

Part No.	W	W1
0821300300	217.5	52
0821300301	217.5	52
0821300302	217.5	52
0821300303	217.5	52
0821300304	217.5	52
0821300307	217.5	52
0821300308	217.5	52
0821300305	217.5	52
0821300330	217.5	52
0821300331	217.5	52
0821300332	217.5	52
0821300333	217.5	52
0821300334	217.5	52
0821300335	217.5	52

Flow rate characteristic, $p_2 = 0,05 - 7$ bar Pressure characteristics curve

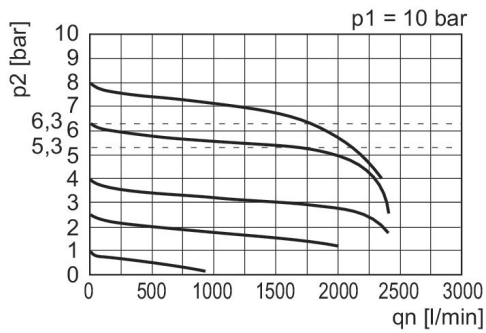

p_1 = Working pressure p_2 = Secondary pressure q_n = Nominal flow

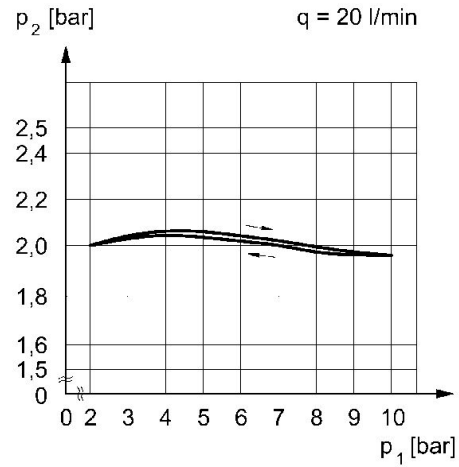

p_1 = working pressure p_2 = secondary pressure q = flow rate