

3/2-shut-off valve, mechanically operated, Series NL4-BAV

0821300913

General series information Series NL4

- The AVENTICS Series NL maintenance units are suitable for all areas: as individual components or as assembled maintenance units, for centralized or decentralized compressed air preparation, in compact or powerful versions, for use in high or low temperatures. This line offers a complete, customizable compressed air preparation technology. It includes an option to combine every component in the Series to achieve the desired function, making it possible to adjust the components precisely to the application requirements.

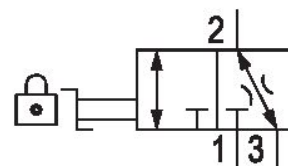

Technical data

Industry	Industrial
Activation	Mechanical
Nominal flow Qn	11000 l/min
Compressed air connection	G 3/4
Working pressure min.	0 bar
Working pressure max	16 bar
Actuating element	rotary switch
Sealing principle	metal/metal sealing
Type	Ball Valve
Parts	Shut-off valve
Lock type	lockable
Lock type	for padlocks
Min. ambient temperature	-10 °C

Max. ambient temperature	60 °C
Medium	Compressed air Neutral gases
Compressed air connection, exhaust	G 1/2
Nominal flow Qn 1 to 2	11000 l/min
Nominal flow Qn 2 to 3	110 l/min
Weight	0.82 kg
Housing material	Die cast zinc
Seal material	Acrylonitrile butadiene rubber
Material, front cover	Acrylonitrile butadiene styrene
Material actuating control	Polyoxymethylene
Part No.	0821300913

Technical information

The pressure dew point must be at least 15 °C under ambient and medium temperature and may not exceed 3 °C .

Nominal flow Qn with secondary pressure p2 = 6 bar at $\Delta p = 1$ bar

A change in the flow direction (from air supply on the left to air supply on the right) occurs by rotating installation by 180° about the vertical axis. Please see the operating instructions for further details.

Dimensions

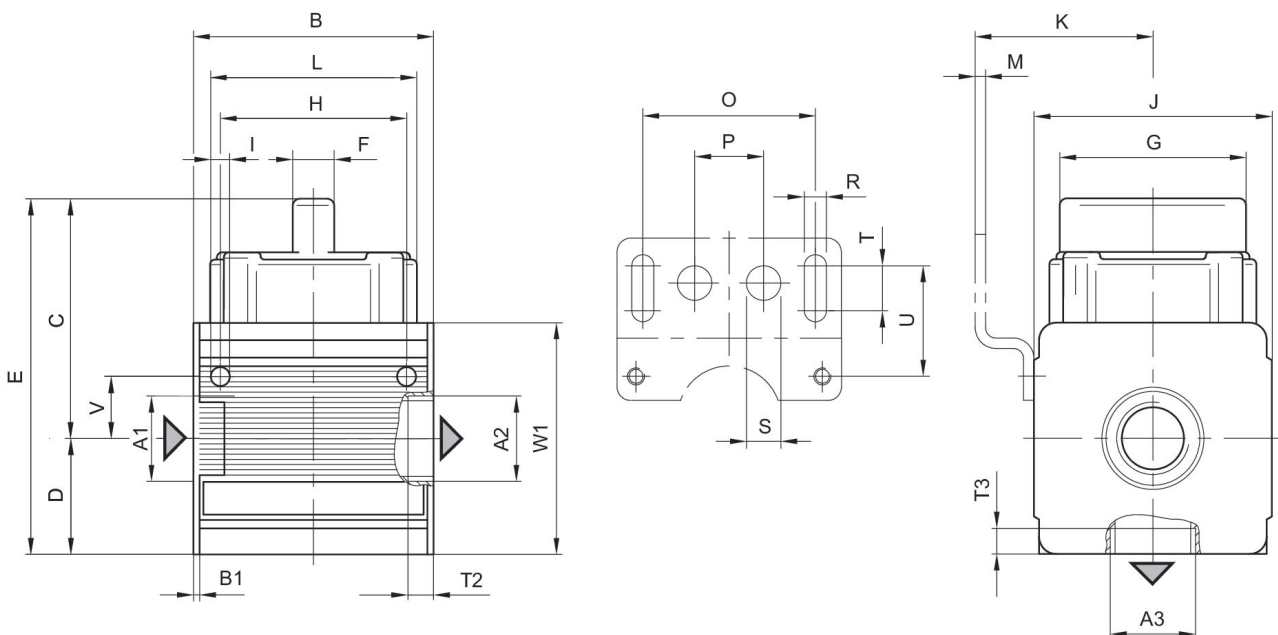

A1 = input
 A2 = output
 A3 = ventilation port

Dimensions in mm

Part No. G 1/2	A1	A2	A3	B	B1	C	D	E	F
0821300912 G 1/2	G 3/8	G 3/8	G 1/2	69.6	1.8	69.5	33.5	103	12
0821300911	G 1/2	G 1/2	G 1/2	69.6	1.8	69.5	33.5	103	12
0821300913	G 3/4	G 3/4	G 1/2	69.6	1.8	69.5	33.5	103	12

Part No. G 1/2	H	G	I	J	K	L	M	O	P
0821300912 G 1/2	54	60	5.5	69	54.5	60	3	50	20
0821300911	54	60	5.5	69	54.5	60	3	38	20
0821300913	54	60	5.5	69	54.5	60	3	50	20

Part No. G 1/2	R	S	T	T2	T3	U	V	W1
0821300912 G 1/2	6.4	10	13	10.5	10.5	33	18	67
0821300911	6.4	10	13	10.5	10.5	33	18	67
0821300913	6.4	10	13	10.5	10.5	33	18	67