

AVENTICS Series NU1 Fittings with tube nuts

AVENTICS Series NU1, are a complete range of plastic fittings with tube nuts, Versatile and safe NU1 plastic fittings with nuts benefit of a large selection of connection type.



Technical data

Industry	Industrial
Fitting type	2x banjo union
Port G	G 1/8
Port D	Ø 6
Type	NU1-S-RT1
Min. working pressure	0 bar
Max. working pressure	10 bar
Min. ambient temperature	-10 °C
Max. ambient temperature	60 °C
Delivery unit	10 piece

Material

Housing material	Polyoxymethylene
Part No.	1823391115

Dimensions

Series NU1

2024-04-04

1823391115

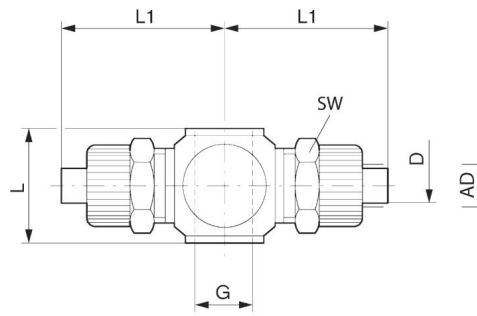

Part No.	Port D	Port G	L	L1	SW	AD 1)
1823391114	Ø 4	G 1/8	16.5	23.5	12	6.2
1823391115	Ø 6	G 1/8	16.5	24.5	14	8.2
1823391116	Ø 4	G 1/4	16.5	25.5	12	6.2
1823391117	Ø 6	G 1/4	16.5	26.5	14	8.2

Connection D = inside diameter of the tubing to be used

1) AD = external diameter of the tubing to be used