

Series NU2

AVENTICS Series NU1, are a complete range of plastic fittings with tube nuts, Versatile and safe NU1 plastic fittings with nuts benefit of a large selection of connection type.



Technical data

Industry	Industrial
Fitting type	T-Banjo connection
Compressed air connection type	External thread
Port G	G 1/8
Compressed air connection type 2	plug-in with tube nut
Port D	Ø 4
Type	NU1-S-RTS
Min. working pressure	0 bar
Max. working pressure	10 bar
Min. ambient temperature	-10 °C
Max. ambient temperature	60 °C
Delivery unit	10 piece
Weight	0.014 kg

Material

Housing material	Polyoxymethylene
Part No.	1823391106

Series NU1

2024-04-04

1823391106

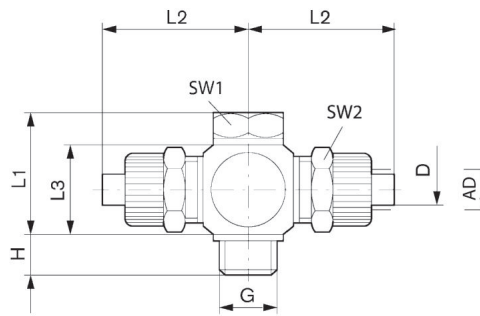

Part No.	Port D	Port G	H	L1	L2	L3	SW 1	SW 2	AD 1)
1823391106	Ø 4	G 1/8	7	20.5	25	16.3	14	12	6
1823391107	Ø 6	G 1/8	7	20.5	25	16.3	14	14	8
1823391108	Ø 4	G 1/4	7.5	21.5	27	16.3	17	12	6
1823391109	Ø 6	G 1/4	7.5	21.5	27	16.3	17	14	8

Connection D = inside diameter of the tubing to be used

1) AD = external diameter of the tubing to be used