

AVENTICS Series NU1 Fittings with tube nuts

AVENTICS Series NU1, are a complete range of plastic fittings with tube nuts, Versatile and safe NU1 plastic fittings with nuts benefit of a large selection of connection type.

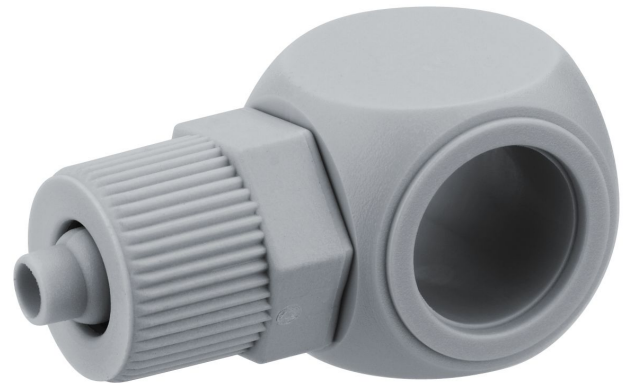

Technical data

Industry	Industrial
Fitting type	1x banjo union
Port G	G 1/8
Port D	Ø 6
Type	NU1-S-RV1
Min. working pressure	0 bar
Max. working pressure	10 bar
Min. ambient temperature	-10 °C
Max. ambient temperature	60 °C
Delivery unit	25 piece

Material

Housing material	Polyoxymethylene
Part No.	1823391111

Dimensions

Series NU1

2024-04-04

1823391111

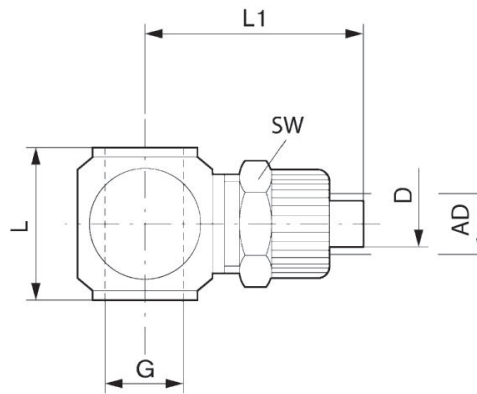

Part No.	Port D	Port G	L	L1	SW	AD 1)
1823391110	Ø 4	G 1/8	16.3	24.5	12	4
1823391111	Ø 6	G 1/8	16.3	24.5	14	6
1823391112	Ø 4	G 1/4	16.3	26.5	12	4
1823391113	Ø 6	G 1/4	16.3	26.5	14	6

Connection D = inside diameter of the tubing to be used
1) AD = external diameter of the tubing to be used