

AVENTICS Series NU1 Fittings with tube nuts

AVENTICS Series NU1, are a complete range of plastic fittings with tube nuts, Versatile and safe NU1 plastic fittings with nuts benefit of a large selection of connection type.



Technical data

Industry	Industrial
Fitting type	Elbow fitting
Port G	R 1/4
Port D	Ø 6
Type	NU1-S-RVT
Min. working pressure	0 bar
Max. working pressure	10 bar
Min. ambient temperature	-10 °C
Max. ambient temperature	60 °C
Delivery unit	10 piece
Weight	0.005 kg

Material

Housing material	Polyoxymethylene
Part No.	1823391272

Series NU1

2024-04-04

1823391272

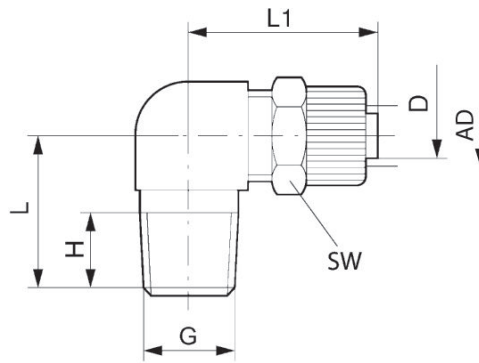

Part No.	Port D	Port G	H	L	L1	SW	AD 1)
1823391269	Ø 4	R 1/8	8	17.5	22	12	6.2
1823391270	Ø 6	R 1/8	8	17.5	22	14	8.2
1823391271	Ø 4	R 1/4	11	21	24	12	6.2
1823391272	Ø 6	R 1/4	11	21	24	14	8.2
1823391273	Ø 9	R 1/4	11	24	26	19	12.4

Connection D = inside diameter of the tubing to be used

1) AD = external diameter of the tubing to be used