

Series NU2

AVENTICS Series NU1, are a complete range of plastic fittings with tube nuts, Versatile and safe NU1 plastic fittings with nuts benefit of a large selection of connection type.



Technical data

Industry	Industrial
Fitting type	Swivel banjo connection 1-fold
Compressed air connection type	External thread
Port G	G 1/8
Compressed air connection type 2	plug-in with tube nut
Port D	Ø 4
Type	NU1-S-RW1
Min. working pressure	0 bar
Max. working pressure	10 bar
Min. ambient temperature	-10 °C
Max. ambient temperature	60 °C
Delivery unit	10 piece
Weight	0.011 kg

Material

Housing material	Polyoxymethylene
Part No.	1823391102

Series NU1

2024-04-04

1823391102

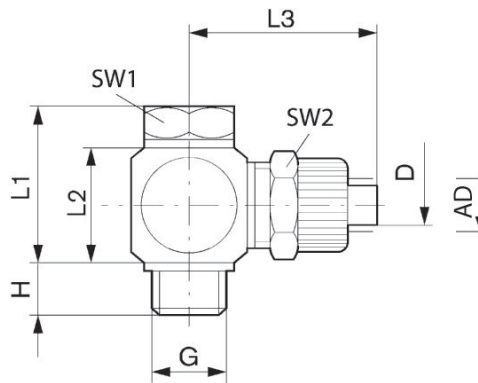

Part No.	Port D	Port G	H	L1	L2	L3	SW 1	SW 2	AD 1)
1823391102	Ø 4	G 1/8	7.7	20.2	16.3	24.5	14	12	6
1823391103	Ø 6	G 1/8	7.7	20.2	16.3	24.5	14	14	8
1823391104	Ø 4	G 1/4	8.8	21	16.3	26.5	17	12	6
1823391105	Ø 6	G 1/4	8.8	21	16.3	26.5	17	14	8

Connection D = inside diameter of the tubing to be used

1) AD = external diameter of the tubing to be used