

## AVENTICS Series NU2 Fittings with tube nuts

AVENTICS Series NU2, are a complete range of plastic and Brass fittings with tube nuts, Versatile and safe NU2 fittings with nuts benefit of a large selection of connection type.

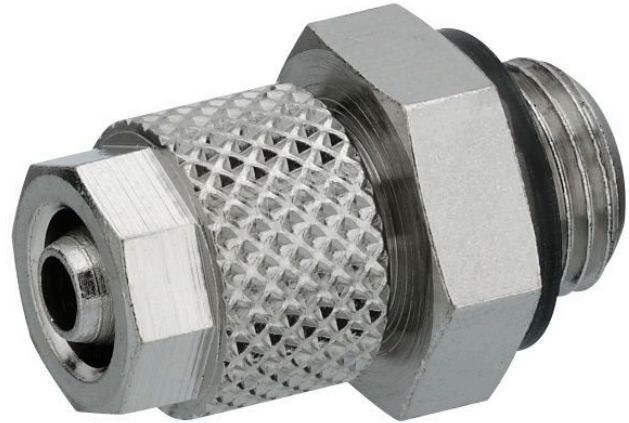

### Technical data

Industry	Industrial
Fitting type	Straight fitting
Compressed air connection type	External thread
Port G	G 3/8
Compressed air connection type 2	plug-in with tube nut
Port D	Ø 9
Type	NU2-S-RPN
Min. working pressure	-0.95 bar
Max. working pressure	15 bar
Min. ambient temperature	-25 °C
Max. ambient temperature	70 °C
Delivery unit	10 piece
Weight	0.03 kg

### Material

Housing material	Brass
Surface housing	nickel-plated
Part No.	1823391032

## Technical information

For use up to -40 °C when using with compressed air tubing series TU1-S-PAM Ø4x1, Ø6x1, Ø8x1, Ø10x1, Ø12x1.5

## Dimensions

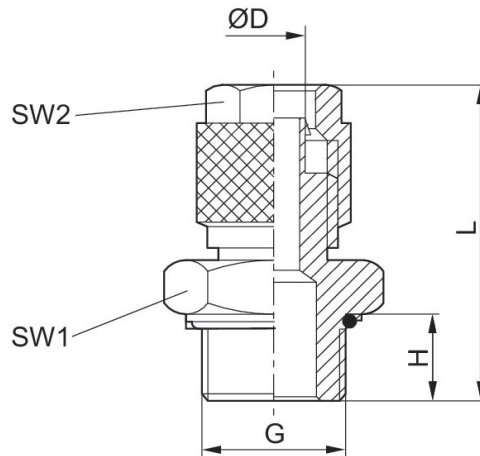

Part No.	Port D	Port G	H	L	SW 1	SW 2
1823391065	Ø 3	M5	3.5	21	8	9
1823391066	Ø 4	M5	3.85	20	8	9
1823391067	Ø 3	G 1/8	4.5	21.7	13	8
1823391008	Ø 4	G 1/8	5.5	23.5	13	10
1823391009	Ø 6	G 1/8	4.5	23	14	12
1823391010	Ø 4	G 1/4	6	25.5	16	10
1823391011	Ø 6	G 1/4	6	25.5	16	12
1823391030	Ø 9	G 1/4	6	29	17	15
1823391031	Ø 6	G 3/8	7	26.5	19	12
1823391032	Ø 9	G 3/8	9	32.5	19	15

Connection D = inside diameter of the tubing to be used