

AVENTICS Series NU2 Fittings with tube nuts

AVENTICS Series NU2, are a complete range of plastic and Brass fittings with tube nuts, Versatile and safe NU2 fittings with nuts benefit of a large selection of connection type.

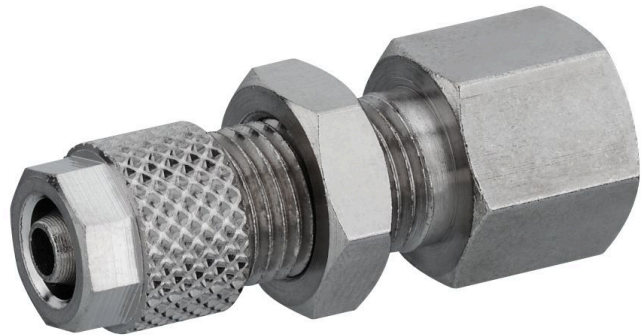

Technical data

Industry	Industrial
Fitting type	Bulkhead connector
Compressed air connection type	Internal thread
Port G	G 3/8
Compressed air connection type 2	plug-in with tube nut
Port D	Ø 6
Type	NU2-S-RSI
Min. working pressure	-0.95 bar
Max. working pressure	15 bar
Min. ambient temperature	-25 °C
Max. ambient temperature	70 °C
Delivery unit	2 piece
Weight	0.066 kg

Material

Housing material	Brass
Surface housing	nickel-plated
Part No.	1823391311

Technical information

For use up to -40 °C when using with compressed air tubing series TU1-S-PAM Ø4x1, Ø6x1, Ø8x1, Ø10x1, Ø12x1.5

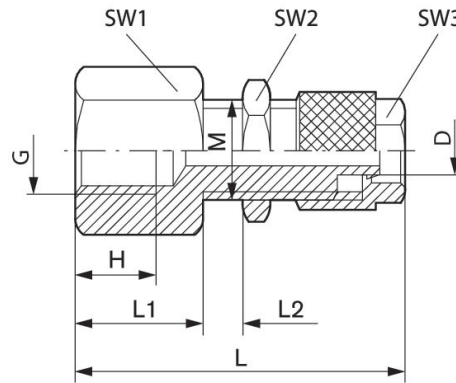

Part No.	Port D	Port G	H	L	L1	L2 1)	M	SW 1	SW 2
1823391306	Ø 3	M5	4.5	29	8	8	M7x0,75	9	10
1823391307	Ø 4	G 1/8	8	38	12	10	M10x1	13	14
1823391308	Ø 6	G 1/8	12	39	12	10	M12x1	17	17
1823391309	Ø 6	G 1/4	12	45	18	10	M12x1	17	17
1823391310	Ø 9	G 1/4	12	47	18	10	M16x1	22	19
1823391311	Ø 6	G 3/8	12	46	19	10	M12x1	17	17

Part No.	SW 3
1823391306	8
1823391307	10
1823391308	12
1823391309	12
1823391310	15
1823391311	12

1) Max.
Connection D = inside diameter of the tubing to be used