

AVENTICS Series NU2 Fittings with tube nuts

AVENTICS Series NU2, are a complete range of plastic and Brass fittings with tube nuts, Versatile and safe NU2 fittings with nuts benefit of a large selection of connection type.

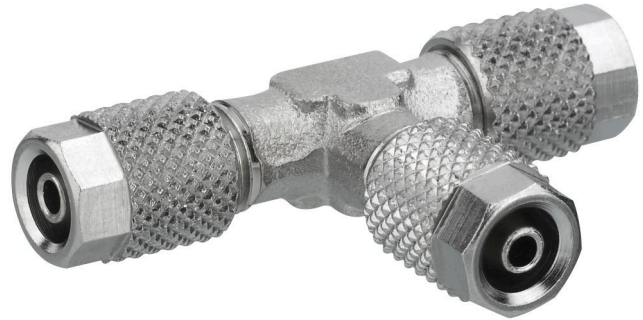

Technical data

Industry	Industrial
Fitting type	T-connector
Compressed air connection type	plug-in with tube nut
Port G	Ø 6
Compressed air connection type 2	plug-in with tube nut
Port D	Ø 8
Type	NU2-S-RTR
Min. working pressure	-0.95 bar
Max. working pressure	15 bar
Min. ambient temperature	-25 °C
Max. ambient temperature	70 °C
Delivery unit	5 piece
Weight	0.035 kg

Material

Housing material	Brass
Surface housing	nickel-plated
Part No.	1823391799

Technical information

For use up to -40 °C when using with compressed air tubing series TU1-S-PAM Ø4x1, Ø6x1, Ø8x1, Ø10x1, Ø12x1.5

Dimensions

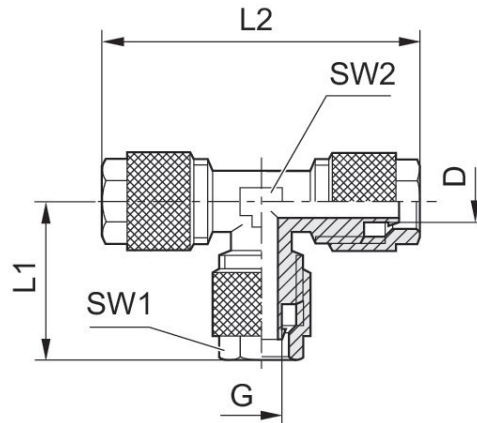

Part No.	Port D	Port G	L1	L2	SW 1	SW 2
1823391794	Ø 3	Ø 3	20.8	41.2	8	8
1823391795	Ø 4	Ø 4	20	41.2	10	8
1823391796	Ø 6	Ø 4	20	40	12	9
1823391797	Ø 6	Ø 6	20	41	12	9
1823391798	Ø 8	Ø 4	19	44	14	11
1823391799	Ø 8	Ø 6	21	44	14	11
1823391800	Ø 8	Ø 8	22.5	45.5	14	11

Connection D = inside diameter of the tubing to be used